

GX-AE SERIES

GX-A/GF-A SERIES

GX-AWP/GF-AWP SERIES

Multi-Function Balances

INSTRUCTION MANUAL

GX-AE series

GX-124AE/GX-224AE/GX-324AE

GX-A series

GX-124A/GX-224A/GX-324A
GX-203A/GX-303A/GX-403A/GX-603A/GX-1003A/GX-1603A
GX-2002A/GX-3002A/GX-4002A/GX-6002A/GX-10002A
GX-6001A/GX-10001A

GF-A series

GF-124A/GF-224A/GF-324A
GF-123A/GF-203A/GF-303A/GF-403A/GF-603A/GF-1003A/GF-1603A
GF-1202A/GF-2002A/GF-3002A/GF-4002A
GF-6002A/GF-10002A/GF-6001A/GF-10001A

GX-AWP series

GX-203AWP/GX-403AWP/GX-603AWP
GX-2002AWP/GX-4002AWP/GX-6002AWP
GX-6001AWP

GF-AWP series

GF-203AWP/GF-403AWP/GF-603AWP
GF-2002AWP/GF-4002AWP/GF-6002AWP
GF-6001AWP

© 2019 A&D Company Ltd. All rights reserved.

No part of this publication may be reproduced, transmitted, transcribed, or translated into any language in any form by any means without the written permission of A&D Company Ltd.

The contents of this manual and the specifications of the instrument covered by this manual are subject to change for improvement without notice.

Windows, Word and Excel are registered trademarks of the Microsoft Corporation.

Contents

1. Introduction	7
1-1. Features	7
1-2. About The Models	8
1-3. About The GX-AE Series.....	8
1-4. Compliance	9
1-5. About Communication Manual	9
2. Part Names, Installation And Precautions.....	10
2-1. Installing The Balance	14
2-2. Precautions	14
2-3. During Use	15
2-4. Precautions After Use.....	17
2-5. Power Supply	17
3. Display Symbols And Key Operation	18
4. Weighing	20
4-1. Units	20
4-2. Basic Operation.....	26
4-3. Counting Mode (PCS)	28
4-4. Percent Mode (%)	30
4-5. Animal Weighing Mode (Hold Function).....	31
5. Impact Shock Detection Function	32
5-1. Recording Impact History.....	33
5-2. Output Impact History.....	33
6. Response Adjustment / Self Check Function	35
6-1. Response Adjustment	35
6-2. Self Check Function / Automatic Setting Of Minimum Weighing Value By ECL	36
6-2-1 With Balance Software Version 1.200 To Version 1.220	37
6-2-2 With Balance Software Version 1.300 or Later	38
7. Sensitivity Adjustment / Calibration Test.....	40
7-1. Automatic Sensitivity Adjustment (GX-AE/GX-A/GX-AWP Series Only).....	42
7-1-1 Inputting The Set Time	43
7-1-2 Clearing The Set Time.....	44
7-1-3 Setting The Interval Time	45
7-2. Sensitivity Adjustment Using The Internal Mass (GX-AE/GX-A/GX-AWP Series Only)	47
7-3. Sensitivity Adjustment Using An External Weight	48
7-4. How To Set The External Weight Value	49

7-5. Correcting The Internal Mass Value Of The GX-AE/GX-A/GX-AWP Series	50
7-5-1 Correcting The Internal Mass Value Of The GX-AE/GX-A/GX-AWP Series (Auto)	51
7-5-2 Correcting The Internal Mass Value Of The GX-AE/GX-A/GX-AWP Series (Manual).....	52
7-6. Calibration Test Using The Internal Mass (GX-AE/GX-A Series 0.0001g Models Only).....	54
7-7. Calibration Test Using An External Weight.....	55
8. Function Switch And Initialization	56
8-1. Permit Or Inhibit	56
8-2. Initializing The Balance	59
9. Function Table.....	60
9-1. Setting The Function Table.....	60
9-2. Details Of The Function Table	62
9-3. Description Of The Class Environment Display	69
9-4. Description Of The Data Output	71
9-5. Description Of The Data Format	71
9-6. Output Example Of The Data Format	71
9-7. Clock And Calendar Function.....	72
9-8. Comparator Function.....	74
9-9. Description Of Application	83
9-10. Output The Function Table Information	84
10. ID Number And GLP Report.....	86
10-1. Main Objective.....	86
10-2. Setting The ID Number.....	87
10-3. GLP Report.....	88
11. Data Memory.....	93
11-1. Data Memory For Weighing Data	93
11-2. Data Memory For Sensitivity Adjustment And Calibration Test	97
12. Statistical Calculation Mode	100
12-1. How To Use The Statistical Calculation.....	100
12-2. Statistical Calculation Mode (Example Of Use)	105
13. Flow Measurement	107
13-1. How To Use Flow Measurement	107
14. Gross Net Tare Function	111
14-1. Preparations For Gross Net Tare Function	111
14-2. Usage Example Of The Gross Net Tare Function.....	113
15. Minimum Weighing Warning Function.....	114

15-1. Minimum Weighing Value Comparison	115
15-2. Input And Output Of The Minimum Weighing Value.....	115
15-2-1 Procedure To Set In The Function Table (With Balance Software Version 1.200 To 1.220)	115
15-2-2 Procedure To Set In The Weighing Display (With Balance Software Version 1.200 To 1.220)	116
15-2-3 Procedure To Set In The Function Table (With Balance Software Version 1.300 Or Later).....	116
15-2-4 Procedure To Set In The Weighing Mode (Balance Software Version 1.300 Or Later)	119
15-2-5 Procedure To Output The Settings In Batch (Balance Software Version 1.300 Or Later)	119
15-3. Setting Measurement Tolerance Of Minimum Weighing Value	121
15-4. Data Output When Less Than Minimum Weighing Value	122
16. Underhook	123
17. Programmable Unit	124
18. Density (Specific Gravity) Measurement.....	126
19. Password Lock Function.....	131
19-1. Balance Software Version 1.200	131
19-2. Balance Software Version 1.211 Or Later	132
19-3. Enabling Password Lock Function	133
19-4. Entering The Password At The Start Of Weighing	134
19-5. Logging Out.....	135
19-6. Registering (Changing) Password	136
19-7. Changing Password	137
19-8. Deleting Password (<i>USER</i> 01 to 10)	138
19-9. If Password Is Lost Or Forgotten	138
20. Repeatability Check Function (GX-AE/GX-A/GX-AWP Series Only)	139
21. Interface Specification (Standard).....	140
22. Maintenance	141
22-1. Treatment Of The Balance	141
23. Troubleshooting	142
23-1. Checking The Balance Performance And Environment.....	142
23-2. Error Codes	143
23-3. Other Display.....	146
23-4. Asking For Repair.....	146
24. Connection With Peripheral Device	147
24-1. Command.....	147
24-2. Key Lock Function.....	147
25. How To Check The Software Version Of The Balance	148
26. Specifications.....	149

26-1. Common Specifications.....	149
26-1-1 Function.....	149
26-1-2 Size/Weight	149
26-2. Individual Specifications.....	150
26-2-1 0.0001g Models	150
26-2-2 0.001g Models	151
26-2-3 0.01g Models	152
26-2-4 0.1g Model.....	153
27. External Dimensions	154
27-1. Options And Peripheral Instruments	157

1. Introduction

This manual describes how the GX-AE/GX-A/GF-A/GX-AWP/GF-AWP series balance works and how to get the most out of it in terms of performance. Read this manual thoroughly before using the balance and keep it at hand for future reference.

Behavior may differ depending on the software version of your balance.

For confirmation of the software version of the balance, refer to "25. How To Check The Software Version Of The Balance".

1-1. Features

- The balance has a self-check function that inspects the balance itself using electronically controlled load (ECL) and evaluates performance.
 - The balance can detect impact applied to its mass sensor and display the level of that impact. ISD (Impact Shock Detection).
 - Continuous change of the balance can be calculated as flow rate, displayed and output. FRD (Flow Rate Display)
 - The balance is equipped with a data memory function, which can record weighing value, sensitivity adjustment result, and multiple unit mass (mass per sample in counting mode) (Up to 200 items are stored for weighing value).
 - The GX-AE/GX-A/GX-AWP series has automatic sensitivity adjustment using the internal mass, adapting to temperature changes, setting time and interval time.
 - Good Laboratory Practice (GLP) / Good Manufacturing Practice (GMP) data can be output using the RS-232C serial interface when performing sensitivity adjustment or calibration test. It is possible to print and record the results using an optional printer.
 - A built-in clock and calendar that can add the time and date to the output data. (Setting and changing of the time can be limited to only Administrator by using the password lock function.)
 - Comparator Indicators, displaying the comparison results with . (Depending on the setting, 5-step comparison is also possible.)
 - Capacity Indicator, displaying the weight value in percentage relative to the weighing capacity.
 - Hold Function, provided for weighing a moving object such as an animal.
 - Underhook, for measuring density and weighing magnetic materials.
 - Using the key lock function, key operation of the balance is disabled and operations can be made by commands from an external device only.
 - Users of the balance can be limited by setting a password. (Password lock function)
 - The balance is equipped with an RS-232C serial interface and a USB interface to communicate with a computer. Windows computer using the Windows communication tools software (WinCT) make building a system very easy. The latest WinCT software can be downloaded from the A&D website.
- Windows is a registered trademark or trademark of Microsoft Corporation in the United States and other countries.
- A small breeze break is included with the 0.001 g readability model.
 - A glass breeze break is included with the 0.0001 g readability model.
 - Dustproof and waterproof performance (IP65) of the product is that suitable for measuring powders and liquids. When the optional waterproof RS-232C cable (AX-KO2737-500) is connected, protection against dust and water can be provided even during communication. (GX-AWP/GF-AWP only)

*If other than GXA-09 is used, protection against dust and water is not provided.

1-2. About The Models

The GX-AE/GX-A/GF-A/GX-AWP/GF-AWP series consists of a variety of models with different combinations of weighing capacity and readability. In this manual, they are classified by readability as shown in the table below.

Classification	Readability	Model		
		Internal mass type, with ionizer	Internal mass type	General type
0.0001 g model	0.0001 g	GX-124AE GX-224AE GX-324AE	GX-124A GX-224A GX-324A	GF-124A GF-224A GF-324A
0.001 g model	0.001 g	\	GX-203A / GX-303A GX-403A / GX-603A GX-1003A / GX-1603A GX-203AWP/GX-403AWP GX-603AWP	GF-123A/ GF-203A / GF-303A /GF-403A / GF-603A /GF-1003A / GF-1603A / GF-203AWP GF-403AWP / GF-603AWP
0.01 g model	0.01 g		GX-2002A / GX-3002A / GX-4002A / GX-6002A / GX-10002A GX-2002AWP/GX-4002AWP GX-6002AWP	GF-1202A/ GF-2002A / GF-3002A /GF-4002A / GF-6002A /GF-10002A GF-2002AWP/GF-4002AWP GF-6002AWP
0.1 g model	0.1 g		GX-6001A / GX-10001A GX-6001AWP	GF-6001A / GF-10001A GF-6001AWP

- The GX-AE/GX-A/GX-AWP series has an internal mass for sensitivity adjustment.
- The GF-A/GF-AWP series does not have an internal mass for sensitivity adjustment, so an external weight is required separately for sensitivity adjustment

1-3. About The GX-AE Series

In general, when the ambient humidity is less than 45%RH, nonconductors such as powders, paper, and plastics easily become charged with static electricity. The influence of static electricity may cause a weighing error of several milligrams. The ionizer neutralizes this electrical charge.

- An ionizer (static eliminator), which causes no breeze, is built into the breeze break. The ionizer can eliminate static electricity from the weighing sample before weighing, reducing error due to static electricity. (Static is eliminated by bipolar ions generated by direct-current corona discharge being projected onto the sample.)
- The ionizer electrodes are designed to be removed for cleaning and replacement.
- An IR (touchless) switch is attached to the ionizer, and static elimination can be started without touching ionizer.
- Power is supplied from the balance to allow the ionizer to be operated without using an AC adapter.
- PRINT or RE-ZERO or the static elimination function of the ionizer can be operated by using the optional foot switch (AX-SW137-PRINT or AX-SW137-REZERO).
- A removable glass breeze break is equipped as standard.
- As an option board is installed, so other options (GXA-03/04/06/09/17/23/24/25/26, FXi-08, etc.) cannot be used.
- For instructions on using the ionizer and IR switch, download the instruction manual for "GXA-17 Large Glass Breeze Break with Ionizer" from our website (<https://www.aandd.jp>) and refer to it.

1-4. Compliance

Compliance with FCC Rules

Please note that this equipment generates, uses and can radiate radio frequency energy. This equipment has been tested and has been found to comply with the limits of a Class A computing device pursuant to Subpart J of Part 15 of FCC rules. These rules are designed to provide reasonable protection against interference when equipment is operated in a commercial environment. If this unit is operated in a residential area, it may cause some interference and under these circumstances the user would be required to take, at his own expense, whatever measures are necessary to eliminate the interference.

(FCC = Federal Communications Commission in the U.S.A.)

1-5. About Communication Manual

For details about communication, download "Communication manual" from our website (<https://www.aandd.jp>) and refer to it.

2. Part Names, Installation And Precautions

The balance is a precision instrument. Unpack it carefully. The packing contents depend on the balance model. See the illustrations to confirm that everything is included. When options are combined at time of shipping, optional accessories may be included.

Keep the packing material to be used for transporting the balance in the future.

GX-AE / GX-A / GF-A 0.0001g models

GX-A/GF-A
Glass Breeze Break

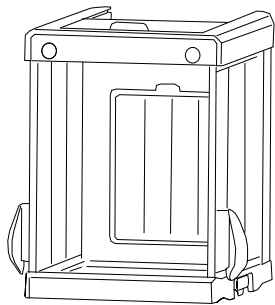

GX-AE
Glass Breeze Break with Ionizer

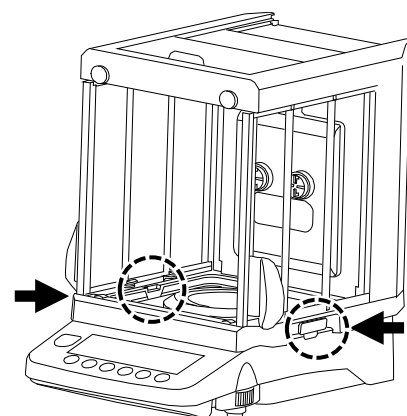
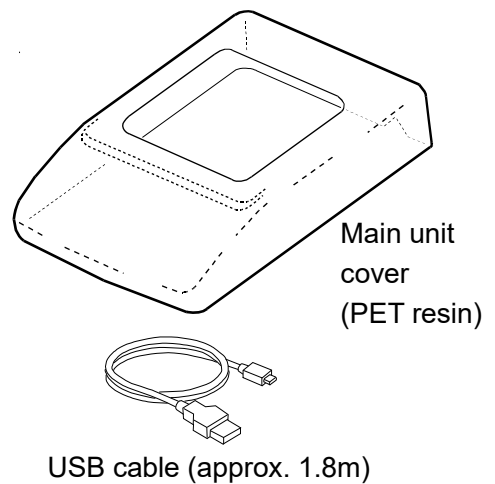
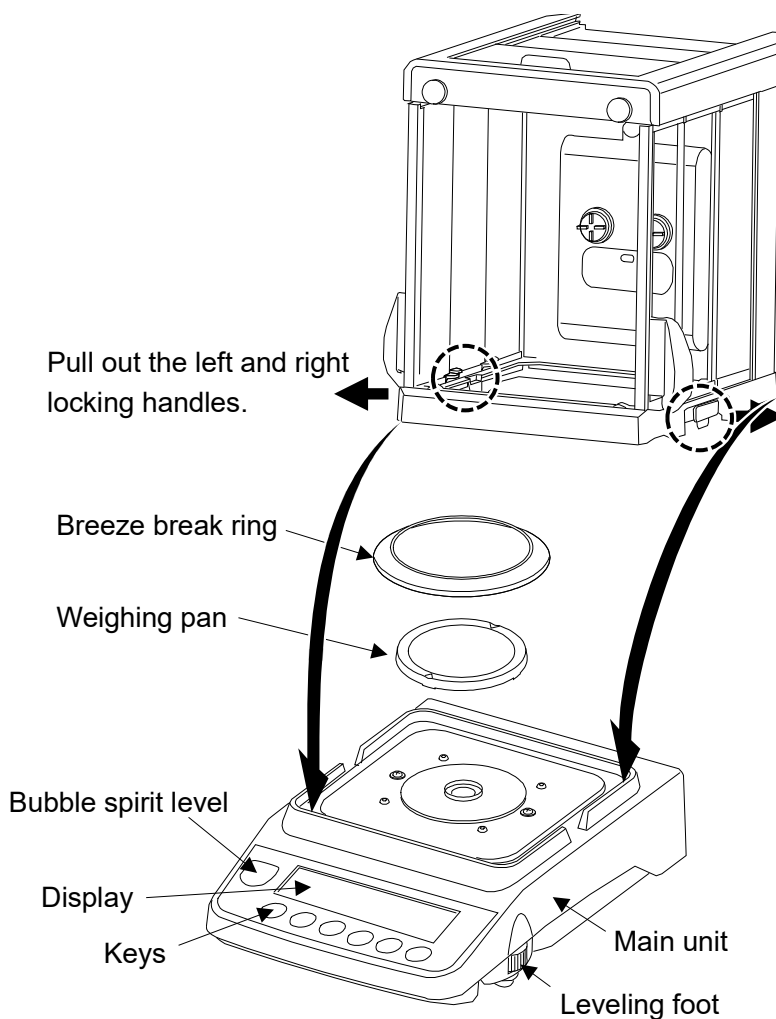
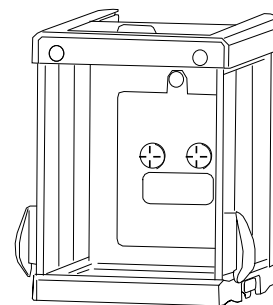

Main unit rear side

The models with an ionizer built in to the glass breeze break (GX-124AE/GX-224AE/GX-324AE) have an ionizer connector, IR sensor connector and external key jack.

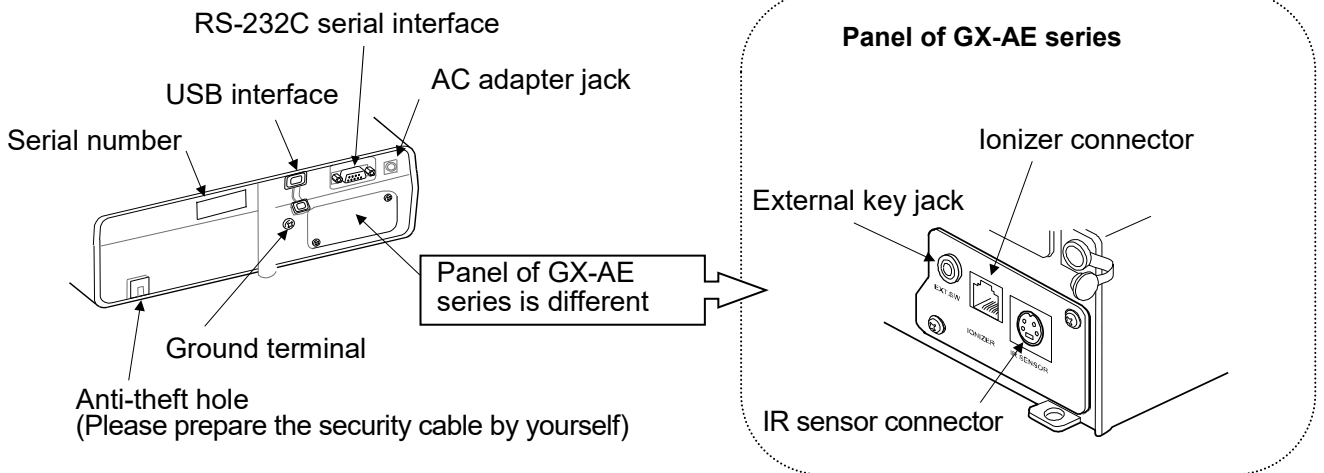

Connecting the glass breeze break with ionizer and the IR sensor

Models: GX-124AE / GX-224AE / GX-324AE

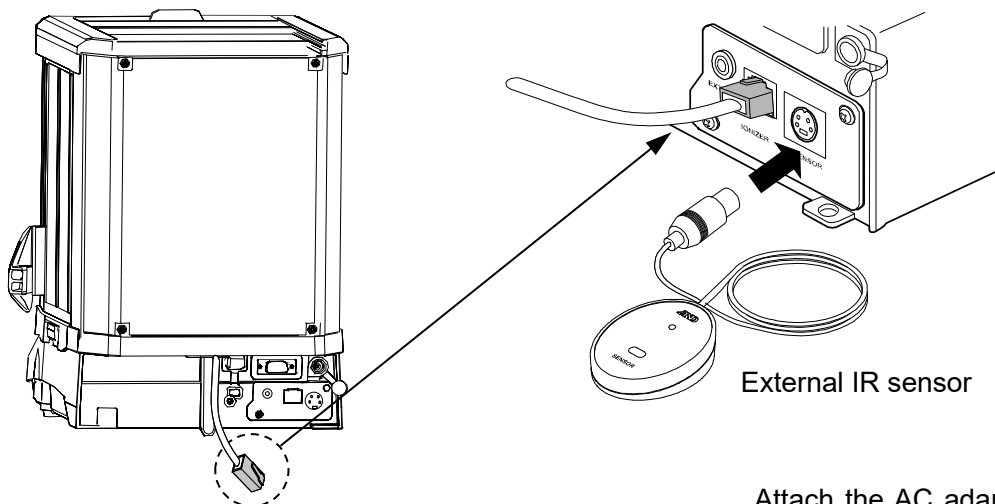

- Insert the cable extending from the rear of the breeze break into the ionizer connector at the rear of the balance.
- Insert the IR sensor plug into the IR sensor connector at the rear of the balance.

Attach the AC adapter label to the adapter as shown below.

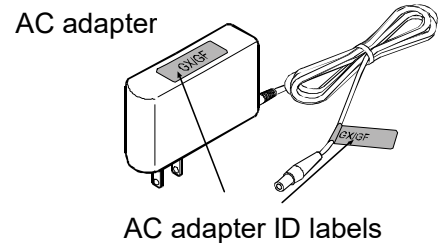

Note

- Please confirm that the AC adapter type is correct for your local voltage and receptacle type.
- Please use the dedicated AC adapter specified for the balance.
- Do not use the AC adapter provided with the balance for other models or equipment with which the AC adapter may not be compatible.
- If you use the wrong AC adapter, the balance and other equipment may not operate properly.

GX-A / GF-A 0.001g models

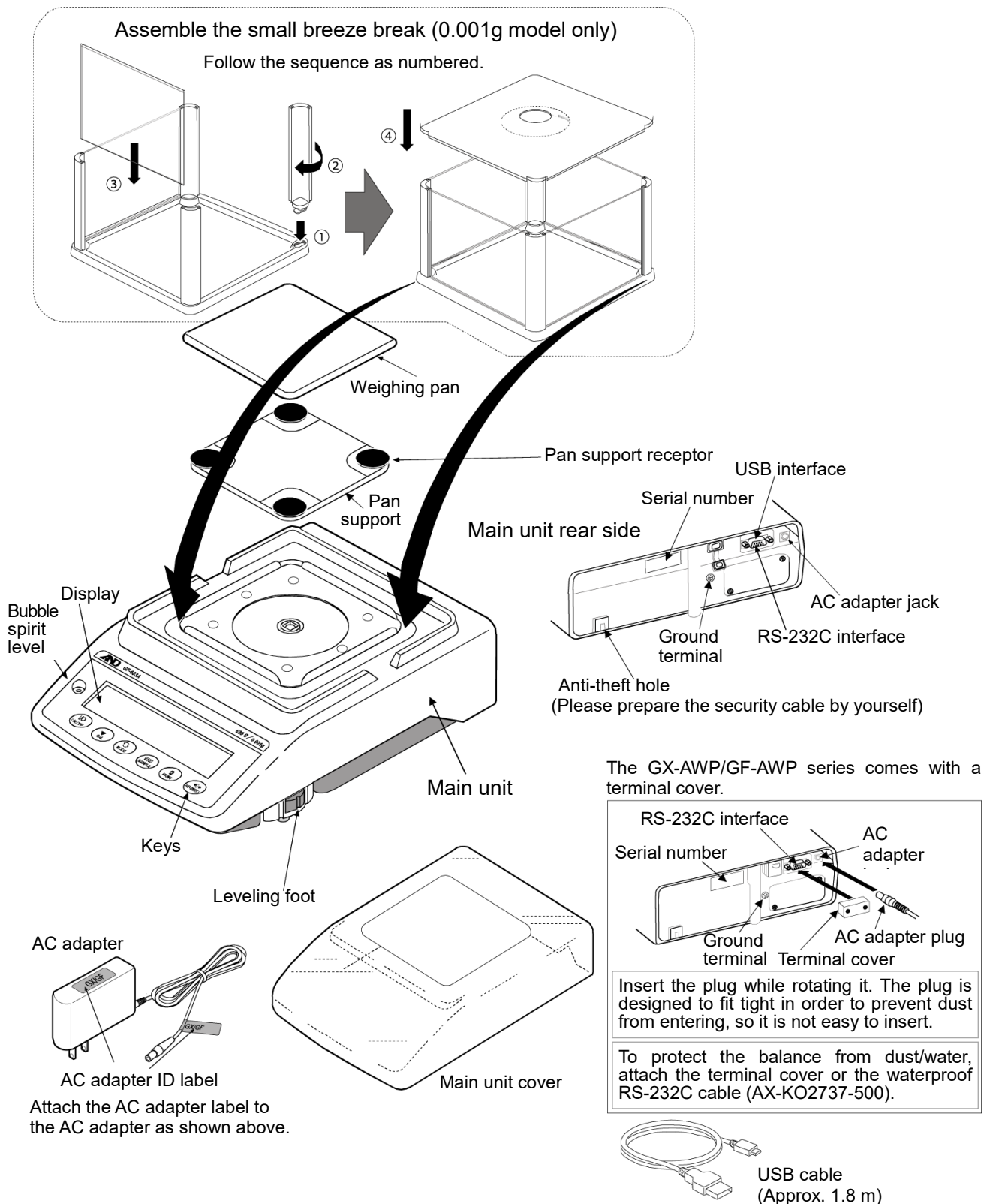

Note

- Please confirm that the AC adapter type is correct for your local voltage and receptacle type.
- Please use the dedicated AC adapter specified for the balance.
- Do not use the AC adapter provided with the balance for other models or equipment with which the AC adapter may not be compatible.
- If you use the wrong AC adapter, the balance and other equipment may not operate properly.

GX-A / GF-A 0.01g/0.1g models

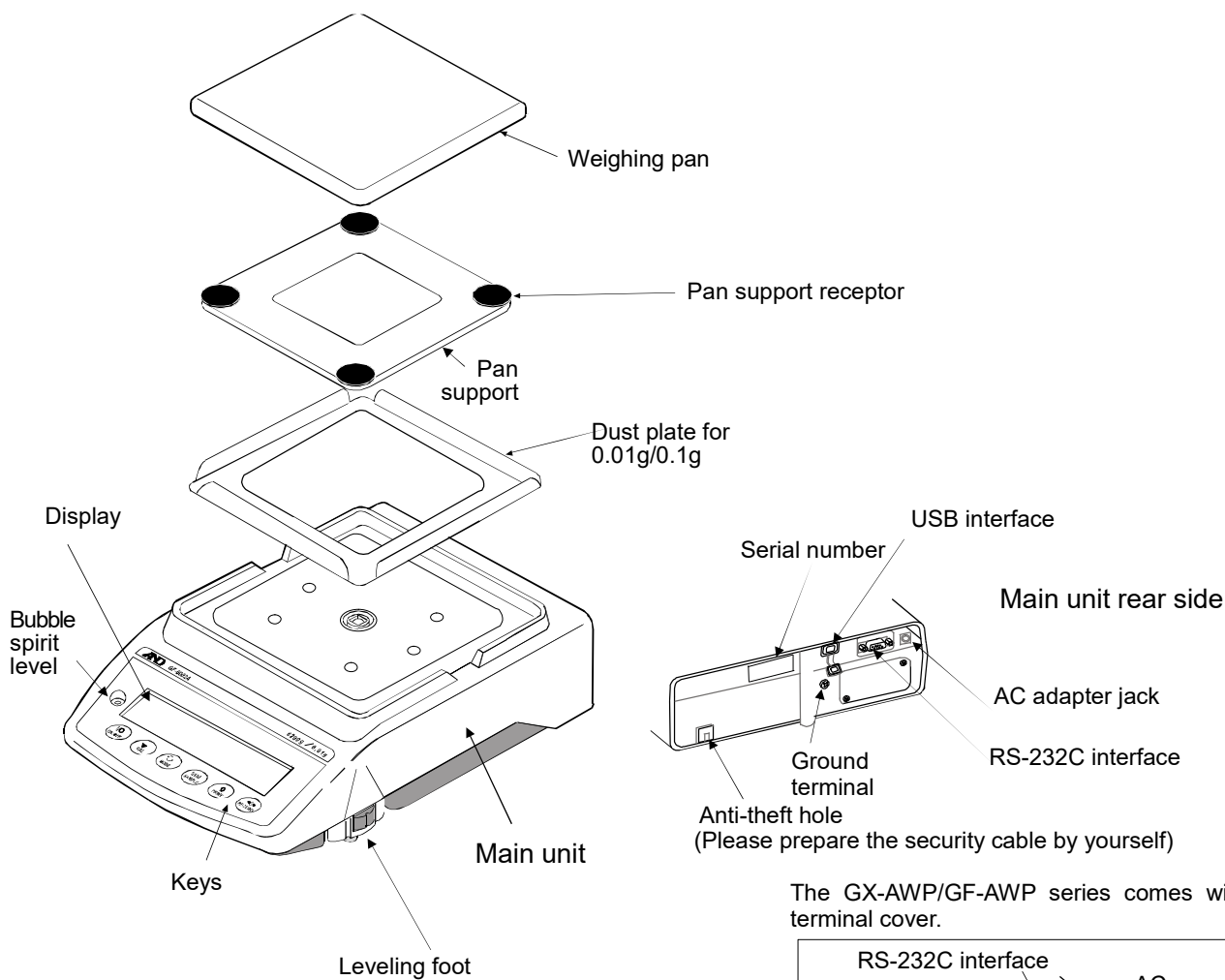

The GX-AWP/GF-AWP series comes with a terminal cover.

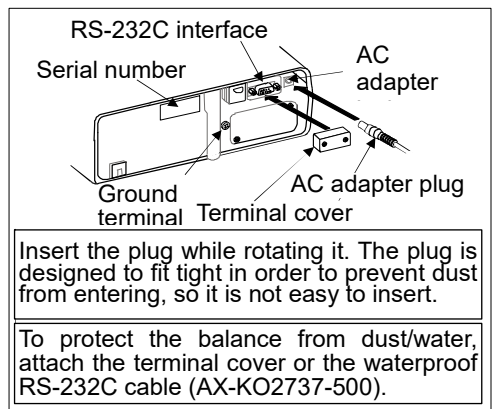

To protect the balance from dust/water, attach the terminal cover or the waterproof RS-232C cable (AX-KO2737-500).

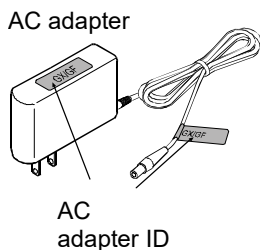

Attach the AC adapter label to the AC adapter as shown above.

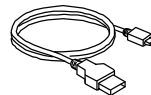
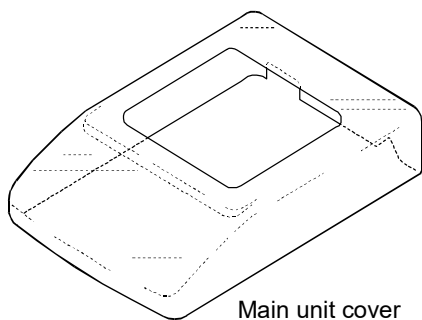

USB cable (Approx. 1.8 m)

Note

- Please confirm that the AC adapter type is correct for your local voltage and receptacle type.
- Please use the dedicated AC adapter specified for the balance.
- Do not use the AC adapter provided with the balance for other models or equipment with which the AC adapter may not be compatible.
- If you use the wrong AC adapter, the balance and other equipment may not operate properly.

2-1. Installing The Balance

- Step 1. Decide where to install the balance, taking into consideration the content of "2-2 Precautions", below.
- Step 2. Assemble the balance while referring to the explanations in the previous section.
- Step 3. To level the balance, adjust the leveling feet so that the air bubble is in the red circle of the bubble spirit level.
- Step 4. Confirm that the adapter type is correct for the local voltage and power receptacle type.
- Step 5. Insert the AC adapter into the AC adapter jack on the rear of the balance, and then plug the AC adapter into an outlet.

2-2. Precautions

To get the optimum performance from the balance and acquire accurate weighing data, note the following:

- Install the balance in an environment where the temperature and humidity are not excessive. The best operating temperature is about $20^{\circ}\text{C} \pm 2^{\circ}\text{C}$ at about 45~60%RH relative humidity.
- Install the balance where it is free of dust.
- The weighing table should be solid, free from vibration and drafts, and as level as possible. (An anti-vibration table or stone table is ideal)
- Install the balance in a stable place avoiding vibration and shock. Corners of rooms on the first floor are best, as they are less prone to vibration.
- Install the balance where it is not affected by heaters or air conditioners.
- Install the balance where it is not exposed to direct sunlight.
- Install the balance away from equipment which produces magnetic fields.
- Level the balance by adjusting the leveling feet and confirm it using the bubble spirit level.
- Be sure to warm up the balance before use for at least 30 minutes (with the AC adapter connected to the power supply).
- Adjust the sensitivity of the balance before use or after having moved it to another location. Refer to "7. Sensitivity adjustment".

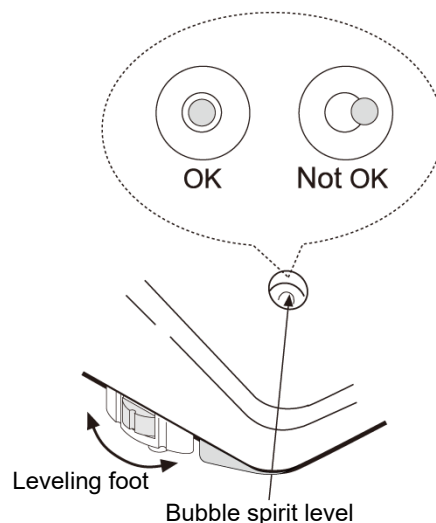

The GX-AWP/GF-AWP series

- The dustproof and waterproof level of the balance is equivalent to IP65, and its second digit, "5", corresponds to "having no harmful influence by receiving direct jet of water". Washing with strong water pressure or submersion in water may cause water to enter the balance and cause a malfunction.
- When installing and using the balance under conditions requiring dustproof and waterproof performance, make sure that the AC adapter plug is fully inserted into the AC adapter jack and that the terminal cover is attached to the RS-232C interface or the waterproof RS-232C cable (AXKO2737-500) is used.
- If the RS-232C terminal cover is removed or the waterproof RS-232C cable (AX-KO2737-500) is not used, protection against dust and water is not provided.

Caution

Do not install the balance where flammable or corrosive gas is present.

How to adjust the level of the balance

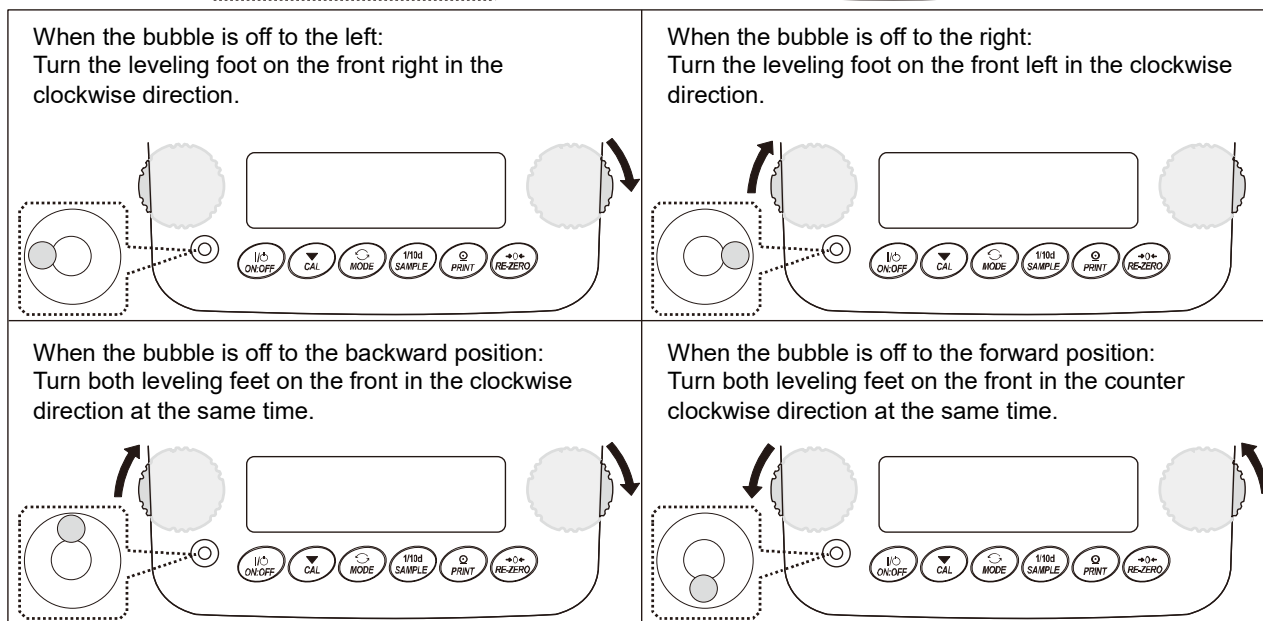
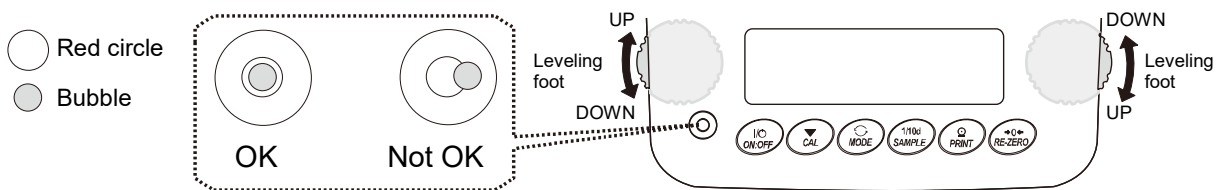

2-3. During Use

For precise and accurate weighing, please take notice of the following.

- Weighing errors may occur due to the influence of static electricity. Note that if the ambient humidity drops below 45%RH, insulators such as plastics are liable to have static electricity. Ground the balance and perform the following as needed.
 - Use the built-in ionizer to remove static electricity (GX-AE series only).
 - Use the GXA-25 or AD-1683A static eliminator, sold separately, to directly remove static electricity from the sample.
 - Increase the relative humidity at the place where the balance is installed.
 - Weigh the sample in a conductive metal container or the like.
 - Wipe off charged materials such as plastic with a damp cloth to suppress static electricity.
- On models that come standard with a small breeze break, the parts of the small breeze break may be charged for some time after being unpacked or when the humidity is low. If the measured value is not stable or repeatability is poor, remove the small breeze break and try again. Wipe the transparent plates with a damp cloth to remove static electricity to solve the problem of them becoming charged. It is also effective to use the GXA-25 or AD-1683A static eliminator, sold separately, or a commercially available antistatic agent.

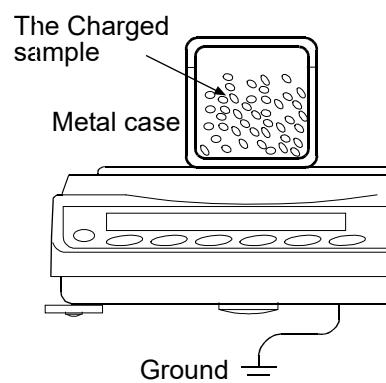

- Influence of magnetism may cause weighing errors. When measuring magnetic materials (iron, etc.), keep the sample away from the balance main body by means such as underhook weighing.
- Weighing errors may occur if there is a difference between the ambient temperature and temperature of the sample (and the container). For example, when the room temperature is 20 °C, convection occurs around a flask that is 40 °C and the balance displays a value lighter than the actual weight. Before weighing the sample and the container, try to acclimatize them to the ambient temperature.
- Perform the weighing operation carefully and quickly. If measurement takes a long time, error-inducing factors will increase due to changes in temperature and humidity in the weighing chamber, air turbulence or reaction/humidity absorption by the sample.
- Do not leave the sample on the weighing pan for an extended period of time. If a sample is left on the weighing pan for a long time, the measured value will change due to deviation from the zero point caused by environmental changes or due to creep phenomenon.
- When placing a sample on the weighing pan, do not drop it, or do not place a sample greater than the balance weighing capacity. Place the sample in the center of the weighing pan.
- When pressing keys, do not press with a sharp object such as a pen. Instead, press the center of the key with your finger.
- Be sure to press the **RE-ZERO** key before weighing in order to eliminate measurement errors.
- Measurement results include error from air buoyancy. The buoyancy of air varies depending on the sample volume, atmospheric pressure, temperature and humidity. Correct the buoyancy for the most precise measurement.
- It is advisable to use the standard accessory display protection cover in order to prevent foreign substances such as powder, liquid and metal pieces from entering the balance.

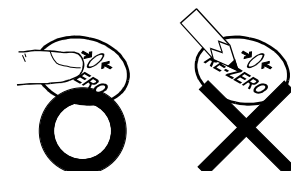
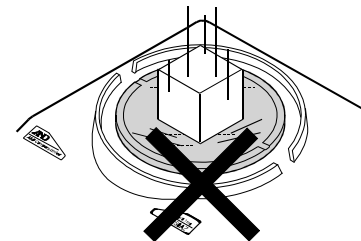
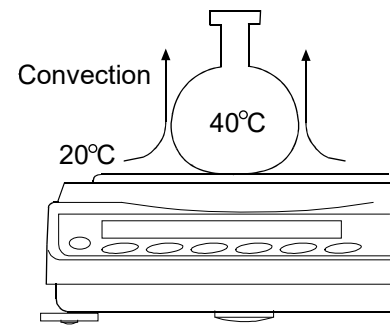
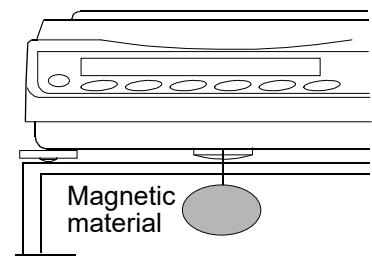

GX-AWP/GF-AWP series

- The balance is dustproof and waterproof, and the case is highly airtight. Therefore, for example, minute pressure fluctuations in the chamber caused by opening and closing the door may cause instability of the display. Before weighing, allow the pressure fluctuations to settle.
- If water droplets or powder remains on the waterproof diaphragm and the pan support boss, the performance of the balance may be impaired. Please clean the balance before using it.
- If the waterproof diaphragm is deformed due to overload, etc., the weighing value may become unstable until the deformation subsides.

2-4. Precautions After Use

- Avoid mechanical shock to the balance.
- Do not disassemble the balance. Contact the local A&D dealer if the balance needs service or repair.
- Do not use organic solvents to clean the balance. Clean the balance with a lint free cloth that is moistened with warm water and a mild detergent.
- Avoid dust and water so that the balance weighs correctly. Protect the internal parts from liquid spills and excessive dust.
- The GX-AWP/GF-AWP series is dustproof and waterproof, but it cannot withstand water pressure due to submersion and the like.

2-5. Power Supply

- When the AC adapter is connected, the balance is in the standby mode if the standby indicator is on. This is a normal state and does not harm the balance. For accurate weighing, keep the AC adapter connected to the balance and AC power unless the balance is not to be used for a long period of time. Please warm up the balance for at least 30 minutes (one hour for 0.0001g models).

3. Display Symbols And Key Operation

Display symbols

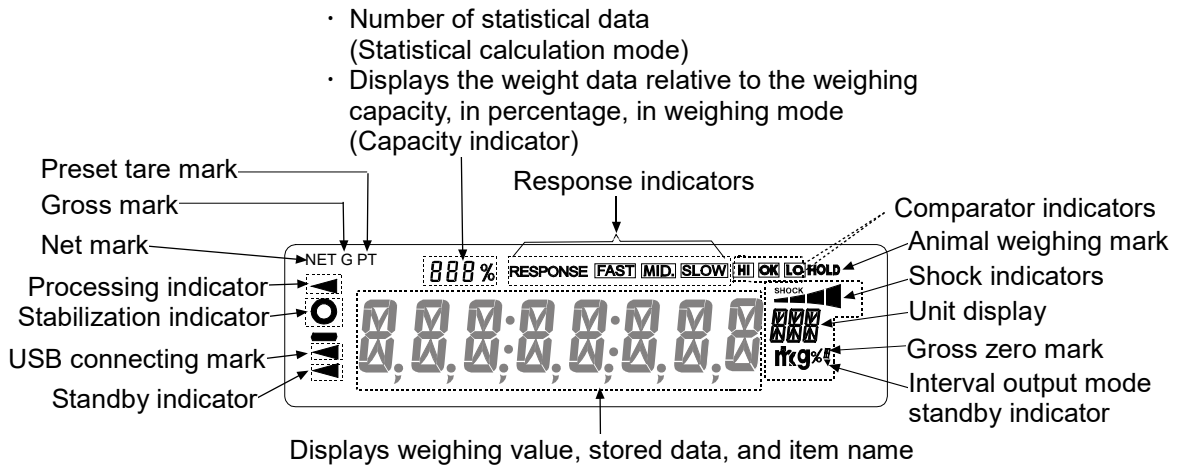

Blinking display contents

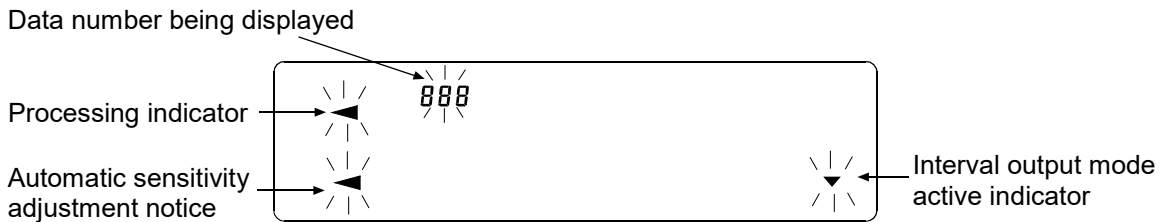

Key operation

Key operations affect how the balance functions. Normal key operation during measurement is "Press and release the key immediately" or "Press the key". Please do not "Press and hold the key (for 2 seconds)" unless required.

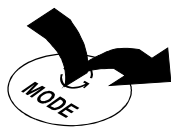



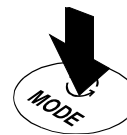

Press the key

(Press and release the key immediately.)



Press and hold the key

for 2 seconds.

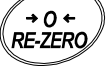
Key	When pressed and released	When pressed and held (for 2 seconds)
	Turns the display ON:OFF . The standby indicator is displayed when the display is turned off. The weighing mode is enabled when the display is turned on. When the password function is enabled, the password input display will be displayed. Refer to "19-4 How to Input The Password At The Start Of Weighing". This ON:OFF key is available anytime. Pressing the ON:OFF key during operation will interrupt operation and turn the display OFF. *	
	In the weighing mode, turns the digit for readability on and off. In the counting or percent mode, enters the sample storing mode.	<ul style="list-style-type: none"> Enters the function table mode. Please refer to "9. Function Table". Runs the repeatability check function when pressed and held for another 2 seconds after the function table menu is displayed. (GX-AE/GX-A/GX-AWP series only) Please refer to "20. Repeatability Check Function".
	Switches the weighing units stored in the function table. Refer to "4. Weighing". Displaying of the unit mg is available for 0.0001g models only.	Please refer to "6-2 Self Check Function/ Automatic Setting Of Minimum Weighing Value by ECL".
	Performs sensitivity adjustment of the balance using the internal mass. (GX-AE/GX-A/GX-AWP series)	Displays other items of the sensitivity adjustment menu.
	Stores the weighing data in memory or outputs to a printer or personal computer depending on the function table settings. (Factory setting = output)	Enters mode to change the unit mass registration number in counting mode. By changing the function table: <ul style="list-style-type: none"> Outputs "Title block" and "End block" for GLP, GMP report. Displays the data memory menu. Enters mode for reading density number in flow measurement.
	Sets the display to zero.	

* When the "Gross net tare function" is selected, the display is turned off by pressing and holding (for 2 seconds). Please refer to "14. Gross Net Tare Function".

4. Weighing

4-1. Units

With the GX-AE/GX-A/GF-A series balance, the following weighing units and weighing modes are available:

Note: The unit "mg" is available for the 0.0001g models only. "mg" is displayed after "g" on 0.0001g models.

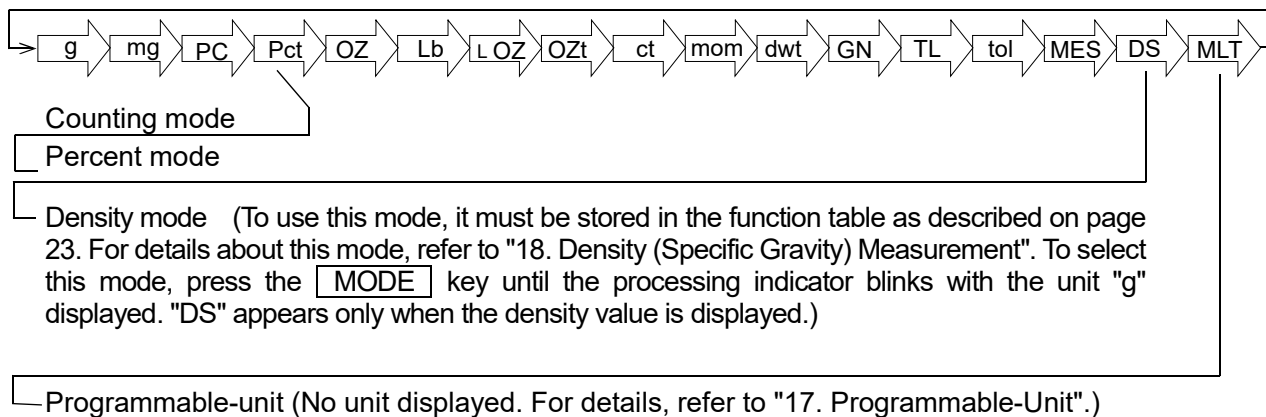

A unit or mode can be selected and stored in the function table as described on page 23.

If a weighing mode (or unit of weight) has been turned off, that mode or unit will be missing in the sequence. Tael has four varieties, one of which can be selected and installed at the factory.

To select a unit or mode for weighing, press the **MODE** key.

For details about the units and modes, see the table below:

Name (unit, mode)	Abbrev.	Display	Function table (Storing mode)	Conversion factor 1 g =
Gram	g	g	g	1 g
Milligram	mg	mg	mg	0.001 g
Counting mode	PCS	PCS	PCS	—
Percent mode	%	%	%	—
Ounce (Avoir)	OZ	oz	oz	28.349523125 g
Pound	Lb	lb	lb	453.59237 g
Pound/Ounce	L OZ	lb oz	lb	1Lb=16 oz, 1 oz=28.349523125 g
Troy Ounce	OZt	ozt	ozt	31.1034768 g
Metric Carat	ct	ct	ct	0.2 g
Momme	mom	mom	mom	3.75 g
Pennyweight	dwt	dwt	dwt	1.55517384 g
Grain (UK)	GN	GN	GN	0.06479891 g
Tael (HK general, Singapore)	TL	TL	TL	37.7994 g
Tael (HK jewelry)				37.429 g
Tael (Taiwan)				37.5 g
Tael (China)				31.25 g
Tola (India)	tol	tol	tol	11.6638038 g
Messghal	MES	MES	MES	4.6875 g
Density mode (See note below)	DS	<input type="text"/> g DS is used to show the density.	DS	—
Programmable-unit (Multi-unit)	MLT	MLt	MLt	—

Note: The blinking processing indicator with “g” indicates that the density mode is selected.

The tables below indicate the weighing capacity and the readability for each unit, depending on the balance model.

Unit	GX-124AE	GX-224AE	GX-324AE	Readability
	GX-124A	GX-224A	GX-324A	
	GF-124A	GF-224A	GF-324A	
	Capacity			
Gram	122	220	320	0.0001
Milligram	122000	220000	320000	0.1
Ounce (Avoir)	4.30	7.05	10.50	0.00001
Troy Ounce	3.92	6.43	9.64	0.00001
Metric Carat	610	1000	1500	0.001
Momme	32.5	53.3	80.0	0.0001
Pennyweight	78.4	128	192	0.0001
Grain (UK)	1882	3086	4629	0.002
Tael (HK general, Singapore)	3.22	5.29	7.93	0.00001
Tael (HK jewelry)	3.25	5.34	8.01	0.00001
Tael (Taiwan)	3.25	5.33	8.00	0.00001
Tael (China)	3.90	6.40	9.60	0.00001
Tola (India)	10.4	17.1	25.7	0.00001
Messghal	26.0	42.6	64.0	0.0001

Unit		GX-203A GX-203AWP	GX-303A	GX-403A GX-403AWP	GX-603A GX-603AWP	GX-1003A	GX-1603A	Readability
	GF-123A	GF-203A GF-203AWP	GF-303A	GF-403A GF-403AWP	GF-603A GF-603AWP	GF-1003A	GF-1603A	
	Capacity							
Gram	122	220	320	420	620	1100	1620	0.001
Ounce (Avoir)	4.30	7.76	11.28	14.81	21.86	38.80	57.14	0.00005
Pound	0.268	0.485	0.705	0.925	1.366	2.425	3.571	0.000005
Pound/Ounce	0Lb 4.30oz	0Lb 7.76oz	0Lb 11.28oz	0Lb 14.81oz	1Lb 5.86oz	2Lb 6.80oz	3Lb 9.14oz	0.01oz
Troy Ounce	3.92	7.07	10.28	13.50	19.93	35.36	52.08	0.00005
Metric Carat	610	1100	1600	2100	3100	5500	8100	0.005
Momme	32.5	58.6	85.3	112.0	165.3	293.3	432.0	0.0005
Pennyweight	78.4	141	205	270	398	707	1041	0.001
Grain (UK)	1882	3395	4938	6481	9568	16975	25000	0.02
Tael (HK general, Singapore)	3.22	5.82	8.46	11.11	16.40	29.10	42.85	0.00005
Tael (HK jewelry)	3.25	5.87	8.54	11.22	16.56	29.38	43.28	0.00005
Tael (Taiwan)	3.25	5.86	8.53	11.20	16.53	29.33	43.20	0.00005
Tael (China)	3.90	7.04	10.24	13.44	19.84	35.20	51.84	0.00005
Tola (India)	10.4	18.8	27.4	36.0	53.1	94.3	138.8	0.0001
Messghal	26.0	46.9	68.2	89.6	132.2	234.6	345.6	0.0005

Unit	GX-2002A GX-2002AWP		GX-3002A	GX-4002A GX-4002AWP	GX-6002A GX-6002AWP	GX-10002A	Readability
	GF-1202A	GF-2002A GF-2002AWP	GF-3002A	GF-4002A GF-4002AWP	GF-6002A GF-6002AWP	GF-10002A	
	Capacity						
Gram	1220	2200	3200	4200	6200	10200	0.01
Ounce (Avoir)	43.0	77.6	112.8	148.1	218.6	359.7	0.0005
Pound	2.68	4.85	7.05	9.25	13.66	22.48	0.00005
Pound/Ounce	2Lb 11.03oz	4Lb 13.60oz	7Lb 0.87oz	9Lb 4.15oz	13Lb 10.69oz	22Lb 7.79oz	0.01oz
Troy Ounce	39.2	70.7	102.8	135.0	199.3	327.9	0.0005
Metric Carat	6100	11000	16000	21000	31000	51000	0.05
Momme	325	586	853	1120	1653	2720	0.005
Pennyweight	784	1414	2057	2700	3986	6558	0.01
Grain (UK)	18827	33951	49383	64815	95680	157410	0.2
Tael (HK general, Singapore)	32.2	58.2	84.6	111.1	164.0	269.8	0.0005
Tael (HK jewelry)	32.5	58.7	85.4	112.2	165.6	272.5	0.0005
Tael (Taiwan)	32.5	58.6	85.3	112.0	165.3	272.0	0.0005
Tael (China)	39.0	70.4	102.4	134.4	198.4	326.4	0.0005
Tola (India)	104	188	274	360	531	874	0.001
Messghal	260	469	682	896	1322	2176	0.005

Unit	GX-6001A GX-6001AWP		GX-10001A	Readability
	GF-6001A GF-6001AWP	GF-10001A		
	Capacity			
Gram	6200	10200	0.1	
Ounce (Avoir)	218	359	0.005	
Pound	13.6	22.4	0.0005	
Pound/Ounce	13Lb 10.69oz	22Lb 7.79oz	0.01oz	
Troy Ounce	199	327	0.005	
Metric Carat	31000	51000	0.5	
Momme	1653	2720	0.05	
Pennyweight	3986	6558	0.1	
Grain (UK)	95680	157410	2	
Tael (HK general, Singapore)	164.0	269.0	0.005	
Tael (HK jewelry)	165.0	272.0	0.005	
Tael (Taiwan)	165.0	272.0	0.005	
Tael (China)	198.0	326.0	0.005	
Tola (India)	531.0	874.0	0.01	
Messghal	1322	2176	0.05	

Storing Units

The units or modes can be selected and stored in the function table. The sequence of displaying the units or modes can be arranged to fit the frequency of use.

The units are stored in non-volatile memory, even if the AC adapter is removed.

Select a unit or mode and arrange the sequence of display as follows:

1. Press and hold the **SAMPLE** key until **bRSFnC** of the function table is displayed, then release the key.
2. Press the **SAMPLE** key several times to display **Unit**.
3. Press the **PRINT** key to enter the unit selection mode.
4. Specify a unit or mode in the order to be displayed using the following keys.

SAMPLE key..... Displays the units sequentially.

RE-ZERO key Specifies a unit or mode. The stabilization indicator **o** appears when the displayed unit or mode is specified. If the key is pressed in units already selected, the stability mark disappears.

5. Press the **PRINT** key to store the units or modes. The balance displays **End** and then displays the next menu of the function table.
6. Press the **CAL** key to exit the function table. Then the balance returns to the weighing mode with the selected unit.
7. To select other unit or mode for weighing, press the **MODE** key.

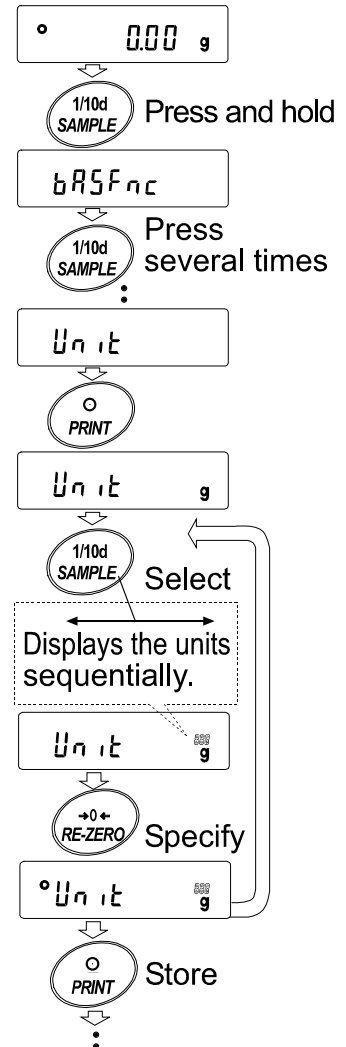

Unit setting example

The example below sets the units in the order with "g" (gram) as the first unit followed by pcs (counting mode).

1. Press and hold the **SAMPLE** key until **bR5Fnc** of the function table is displayed, then release the key.
2. Press the **SAMPLE** key several times to display **Unit**.
3. Press the **PRINT** key to enter the unit selection mode.
4. Press the **RE-ZERO** key to specify the unit of "g"
The stabilization indicator **o** appears when the unit is specified.
5. Press the **SAMPLE** key to display **Unit^{PCS}**.
6. Press the **RE-ZERO** key to specify the unit of pcs.
The stabilization indicator **o** appears when the unit is specified.
7. Press the **PRINT** key to store the units.
The balance displays **End** and then displays the next menu item of the function table.
8. Press the **CAL** key to exit the function table. Then the balance returns to the weighing mode with g, the unit selected first.
9. Press the **MODE** key to switch between g and pcs (g→pcs).

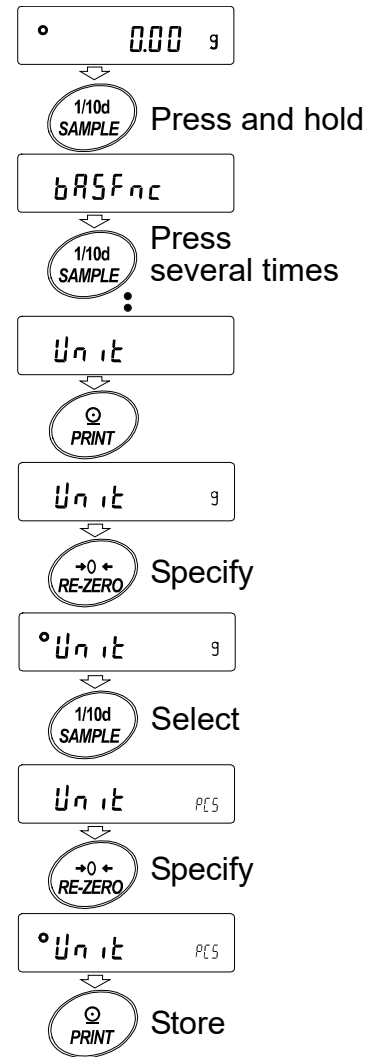

4-2. Basic Operation

1. Press **MODE** key to select a unit.
Here, “g” is selected as an example.
2. Place a container on the weighing pan if necessary.
Press the **RE-ZERO** key to cancel the weight (tare).
The balance displays **0.00 g**. (The decimal point position depends on the balance model.)
3. Place a sample on the pan or in the container. Wait for the stabilization indicator **o** to be displayed. Read the value.
4. Remove the sample and container from the pan.

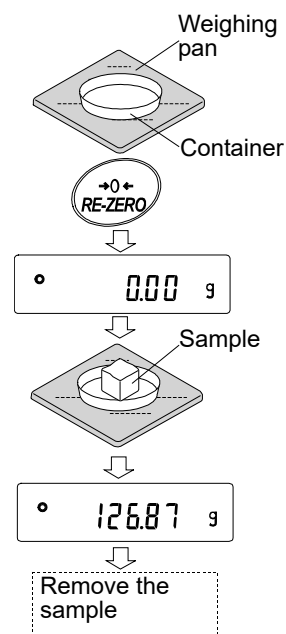

Note

- Press the **SAMPLE** key to turn on or off the digit for the readability.
- The weighing data can be stored in memory. For details, refer to “11. Data Memory”.
- When the **ON:OFF** key is pressed with a container placed on the weighing pan and weighing is started, the balance automatically cancels the weight (tare) and displays **0.00 g**.

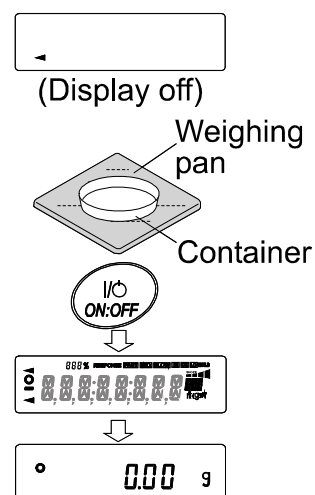

About the operation at when power is turned on

The balance will determine the reference zero point when the **ON:OFF** key is pressed to enter the weighing mode.

Depending on the load condition at that time, it will automatically judge whether to perform zero or tare operation. The condition for determining which is used is "power on zero range", and when power on zero range is exceeded, the tare subtraction operation is performed.

About re-zero operation

By pressing the **RE-ZERO** key, the display can be changed to zero.

Re-zero with the **RE-ZERO** key will automatically determine whether zero or tare operation is performed.

The condition for determining which is used is "zero range", and when zero range is exceeded, the tare subtraction operation is performed.

About measurement range

For the balance, the range that can be weighed is determined by model.

The total amount (net amount + tare quantity) up to the maximum display of each model is displayed, and when the maximum display is exceeded, **E** is displayed to indicate that the weighing range is exceeded. When in excess in negative, **-E** is displayed.

Model		Power on zero range	Zero range	-E display range
GX-124AE, GX-124A,	GF-124A	Approx.±50g	Approx.-50g ~ +2g	Approx.-50g or less
GX-224AE, GX-224A,	GF-224A		Approx.-50g ~ +4g	
GX-324AE, GX-324A,	GF-324A		Approx.-50g ~ +6g	
	GF-123A	Approx.±100g	Approx.-100g ~ +2g	Approx.-100g or less
GX-203A GX-203AWP,	GF-203A GF-203AWP		Approx.-100g ~ +4g	
GX-303A	GF-303A		Approx.-100g ~ +6g	
GX-403A GX-403AWP,	GF-403A GF-403AWP		Approx.-100g ~ +8g	
GX-603A GX-603AWP,	GF-603A GF-603AWP		Approx.-100g ~ +12g	
GX-1003A	GF-1003A		Approx.-100g ~ +20g	
GX-1603A	GF-1603A		Approx.-100g ~ +32g	
	GF-1202A		Approx.±1kg	
GX-2002A GX-2002AWP,	GF-2002A GF-2002AWP	Approx.-1kg ~ +40g		
GX-3002A	GF-3002A	Approx.-1kg ~ +60g		
GX-4002A GX-4002AWP,	GF-4002A GF-4002AWP	Approx.-1kg ~ +80g		
GX-6002A GX-6002AWP,	GF-6002A GF-6002AWP	Approx.-1kg ~ +120g		
GX-10002A	GF-10002A	Approx.-1kg ~ +200g		
GX-6001A GX-6001AWP,	GF-6001A GF-6001AWP	Approx.±1kg		Approx.-1kg ~ +120g
GX-10001A	GF-10001A		Approx.-1kg ~ +200g	

4-3. Counting Mode (PCS)

This is the mode to check the number of pieces. Based on the unit mass of the reference sample (weight of one piece), the balance calculates and displays how many pieces are weighed. The smaller the variation in the unit mass, the more accurate the count (the number of pieces). In addition, the ACAI function described later can be used to further improve the counting accuracy while weighing.

Note

- * It is recommended that the unit mass (weight of one piece) of the sample to be weighed should be at least 10 times the readability (g) of the balance.
- * If there is a large variation in the sample unit mass values, it may not be possible to count accurately.
- * If counting error is large, frequent use of the ACAI function is advisable. As one of the other methods, try dividing the measurement into multiple times.

Selecting the counting mode

1. Press the **MODE** key to select **PCS** (**PCS** = unit)

Storing a sample unit mass

2. Press the **SAMPLE** key to enter the sample unit mass storing mode. Note that even in the storing mode, pressing the **MODE.** key switches to the next mode.
3. To select the number of samples, press the **SAMPLE** key several times. (10→25→50→100→5 pieces)

Note

Since the sample unit mass is usually considered to have some variation, the larger the number of samples for registration, the more accurate the count can be.

4. Place a container on the weighing pan, if necessary.
Press the **RE-ZERO** key to cancel the weight (tare). The number specified in step 3 appears.
25.0 is displayed if 25 is selected in step 3.
5. Place the specified number of samples on the pan. In this example, 25 pieces.
6. Press the **PRINT** key to store the unit mass. The count display appears. (e.g. **25 PCS** is displayed with 25 pieces.)

Note

- * The balance prompts to add more samples if it judges that the loaded sample is too light (resulting in large counting error). Add the displayed number of samples and press the **PRINT** key again. When the unit mass is stored correctly, the counting display appears.
- * If the balance judges that the mass of the sample is too light to be registered as the unit mass, it displays **Lo**.
- * Registered unit mass is stored even when the power is turned off.

Counting mode

7. Counting operation is now possible.

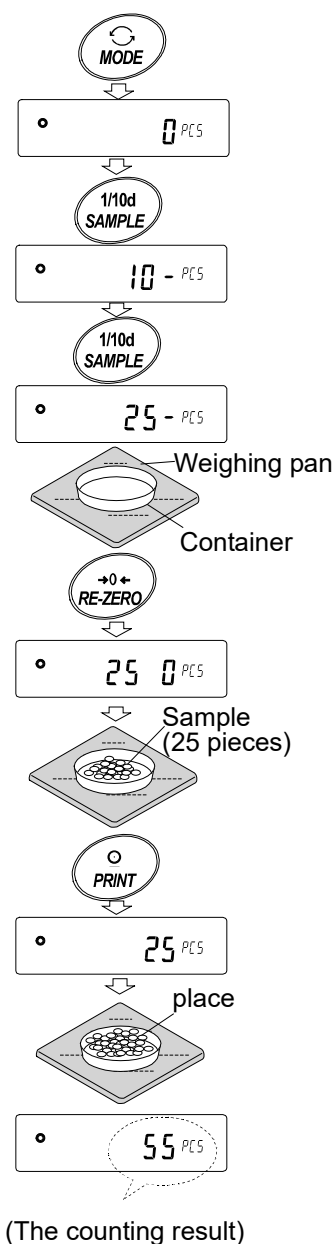

Automatic Counting Accuracy Improvement (ACAI)

This function automatically improves the counting accuracy as the number of samples increases. (Errors will be reduced as sample weight variations are averaged.)

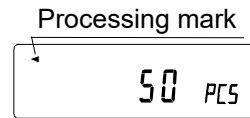

After registering the unit mass in step 6, proceed to step 8 below.

8. Add a few samples. Then the processing indicator turns on. (Three or more samples are required in order to prevent errors. The processing indicator does not turn on if overloaded. Add as many samples as the displayed number.)
9. Do not touch or move the samples on the pan while the processing indicator is blinking. (The accuracy is being updated.)
10. The accuracy is updated after the processing indicator turns out. Each time this process is repeated, the counting accuracy will improve further. The range of ACAI after exceeding 100 is not predetermined. Add as many samples as the displayed number.
11. Remove all the samples used with ACAI from the pan and start counting work.

Note

- Do not change units during ACAI processing.

Storing the unit mass

With the data memory function, up to 50 unit masses can be stored.

1. Set the function setting item "Data memory (DATA)" to "Stores unit mass in counting mode (DATA I)". Refer to "9. Function Table".
2. The selected unit mass registration number is displayed in "P **".
3. Press and hold the **PRINT** key for 2 seconds to go to the mode for changing the unit mass registration number.
 - RE-ZERO** key (+) Changes the registration number.
 - MODE** key (-) Changes the registration number.
 - PRINT** key Confirms the displayed registration number.
 - CAL** key Cancels the displayed registration number.

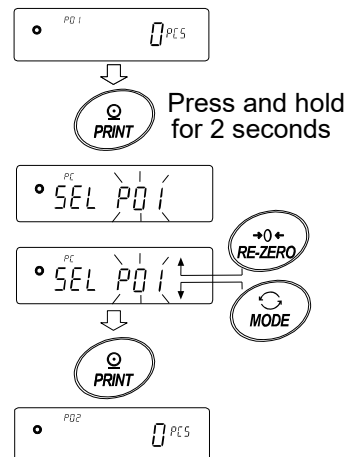

4. Register the unit mass, if necessary. Multiple unit masses can be stored by registering them with different unit mass registration numbers.
 - P **: The unit weight registration number is displayed.

Note

- Unit weight can be read by "UN:mm" command. (mm corresponds to P01 to P50 with 01 to 50.) For details about the communication, download "Communication manual" from our website (<https://www.aandd.jp>) and refer to it.
- The read unit mass can output by "?UW" command and can be changed by "UW:" command.

Caution

- ACAI is not applicable to the read unit mass.

4-4. Percent Mode (%)

The percent mode displays the weighting value in percentage compared with a reference mass as 100%. This is useful for target weighing or sample variance check.

Selecting Percent Mode

1. Press the **MODE** key to select the unit **%** (percent mode).

Storing a Reference Mass as 100%

2. Press the **SAMPLE** key to enter the mode for storing a 100% reference mass.

Note that pressing the **MODE** key switches from this mode to the next mode.

3. Place a container on the weighing pan, if necessary.

Press the **RE-ZERO** key to display **100.00 %**.

4. Place a sample of 100% reference mass on the pan/container.

5. Press the **PRINT** key to store the 100% reference mass.

The balance displays **100.00 %**.

Note

- **Lo** appears if the balance judges that the sample is too light to be registered as a 100% reference mass.
- The decimal point position varies according to the 100% reference mass.

Model	100% mass	Decimal point position
0.0001g readability	0.0100g to 0.0999g	1%
	0.1000g to 0.9999g	0.1%
	1.0000g or more	0.01%
0.001g readability	0.100g to 0.999g	1%
	1.000g to 9.999g	0.1%
	10.000g or more	0.01%
0.01g readability	1.00g to 9.99g	1%
	10.00g to 99.99g	0.1%
	100.00g or more	0.01%
0.1g readability	1.0g to 9.9g	1%
	10.0g to 99.9g	0.1%
	100.0g or more	0.01%

- The stored reference mass is stored in non-volatile memory even if the AC adapter is removed.

Percentage weighing

6. Percentage weighing is now possible.

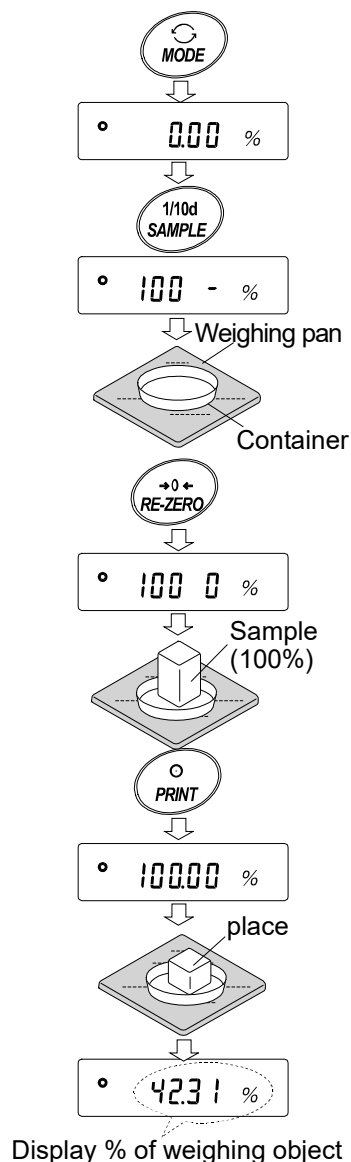

4-5. Animal Weighing Mode (Hold Function)

This is the mode to weigh a moving object such as an animal, even when the display of the weighing data fluctuates. The hold function allows the average weight of the animal to be displayed. To use the hold function, set the function in the function table. Refer to "9. Function Table" and "9-3 Description Of The Class Environment Display" for details.





5. Impact Shock Detection Function

The GX-AE/GX-A/GF-A series has a function to detect impact shocks to the mass sensor section and to display the impact level.

By lowering the impact level at the time of loading, it is possible not only to alleviate variation in the weighing value but also to reduce the risk of failure of the mass sensor section.

Especially when incorporating the balance in a production line, etc. and weighing by means such as an automated system, impact to the sensor may be applied greater than expected. When designing automatic systems and the like, it is recommended that you minimize the impact level as much as possible while checking the shock indicator.

The shock indicator has 5 levels from level 0 to level 4.

Impact level	Shock indicator	Buzzer	Contents
0	No indicator	No beeps	Safe
1	SHOCK 	No beeps	Caution
2	SHOCK 	No beeps	Caution: Alleviate impact shocks
3	SHOCK 	One beep	Warning: Do not apply any more impact shocks
4	SHOCK 	Two beeps	Danger: Sensor may be damaged

With balance software version 1.300 or later, you can turn off the impact shock detection by setting *bRSFnC / ISd* to \square in the function table. Even if the impact shock detection function is turned off, a record is kept in the balance when there is a shock impact.

Note

- Impact on the weighing sensor is not only that applied to the weighing pan when loaded, but also may be impact applied from the table on which the balance is installed. The impact detection function also works for impact coming from the table.

5-1. Recording Impact History

Impacts of impact level 3 or higher are stored on the balance with data and time (up to 50 instances). When the password lock function is ON (Lock 1 or Lock 2), the login user information is added when outputting the impact history. (Balance software version 1.211 or later.)

Note

- If data instances exceeds 50, the stored data with the lowest impact level will be overwritten.
- The stored impact history cannot be deleted.
- Impact data where the balance is not energized (during transport, etc.) is not stored.

5-2. Output Impact History

The stored impact history can be output by sending a specified command to the balance or performing key operation.

Note

- The impact history format differs depending on the software version of the balance.

Output by command

The stored impact data will be output all at once by sending a “?SA” command to the balance.

Output by key operation (Balance software version 1.200 or later.)

1. Press the **ON:OFF** key to turn off the display.
2. With the display off, press the **ON:OFF** key while holding down the **MODE** key.
3. **-L 15t-** is displayed, and the stored impact data is output all at once.

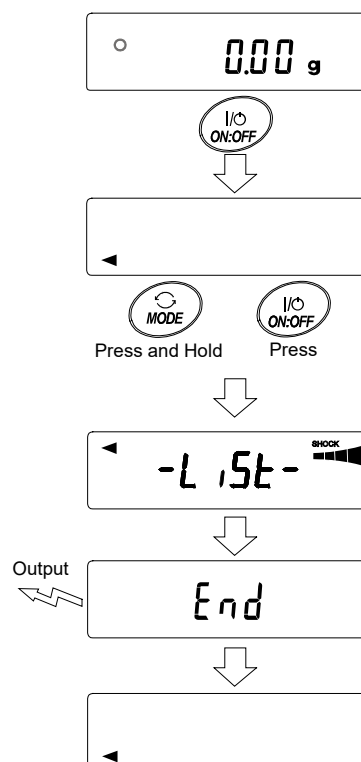

Impact history output example

The impact history format differs depending on the balance software version.

- With balance software version 1.200

Date, time, and impact level are each output on a separate line.

Output example,

2018/05/29

11:08:18

SHOCK LV4

- With balance software version 1.211 or later

Date, time, impact level, login and login user information are output together on one line.

The login user information varies depending on the setting of the login user and the setting of *Lact* in the function table when receiving impact.

Output	Login user	Function table <i>Lact</i>
, --,	No login user	0, 1, 2
,00, ADMIN	Administrator	1
,01~10, USER	User	1
, --, GUEST	Guest	2

Output example

2018/05/29,11:08:18,SHOCK LV,3, --,

2018/05/29,11:12:27,SHOCK LV,4,00,ADMIN

2018/05/29,11:13:38,SHOCK LV,3,01,USER

2018/05/29,11:17:04,SHOCK LV,4, -- ,GUEST

6. Response Adjustment / Self Check Function

Disturbances such as drafts and vibration at the place where the balance is installed affect weighing. In the response adjustment settings, the response characteristics of the balance can be set in three stages according to the disturbance. With the self check function, the balance itself inspects balance operation and checks balance performance.

Indicator	Function setting	Response characteristic
FAST	[ond 0]	Faster response, Lower display stability
MID.	[ond 1]	↑ ↓ Slower response, Higher display stability
SLOW	[ond 2]	Slower response, Higher display stability

Response indicator

6-1. Response Adjustment

Response adjustment can be changed by the following method.

1. Press and hold the [MODE] key for 2 seconds until [RESPONSE] is displayed, and then press the [MODE] key again.
2. Press the [MODE] key to select a weighing speed. [FAST], [MID] or [SLOW] can be selected.
3. After a few seconds of inactivity the balance displays [End].

Then, the balance returns to the weighing mode and displays the updated response indicator.

The response indicator remains displayed for a while (for 30 seconds).

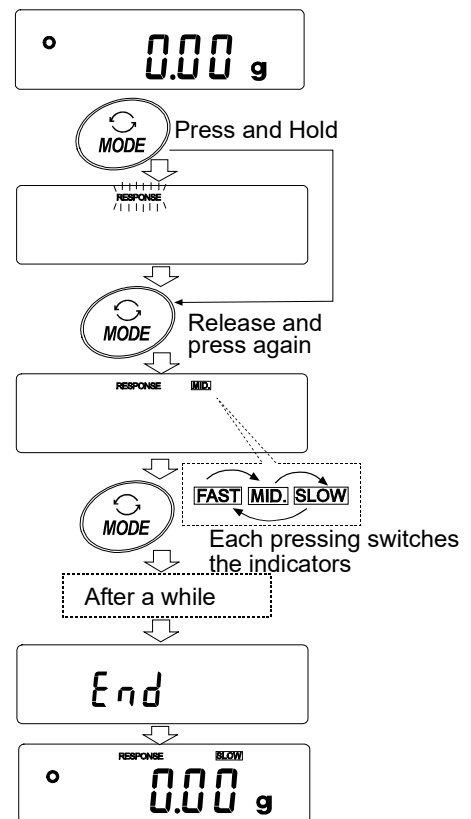

Note

When setting the Response adjustment, "Condition ([ond])" and "Display refresh rate (SPd)" in the Function Table "Environment display (bR5FnC)" are changed as below.

Display	[ond] (Condition)	SPd (Display refresh rate)	S-tb (Stability band width)
FAST	0	2	2
MID.	1	0	1
SLOW	2	0	1

When using a combination other than the above, set individually as shown in "9. Function Table".

Note

If **RESPONSE** is displayed and you leave it without pressing the **MODE** key, the "Self-check function" is activated. Refer to "6-2 Self Check Function". For the setting method, refer to "9. Function Table".

6-2. Self Check Function / Automatic Setting Of Minimum Weighing Value By ECL

With the self check function, repeatability can be confirmed and displayed in addition to performing failure diagnosis, and whether or not the balance's performance is being exhibited can be easily checked. It is also possible to display and register the minimum weighing value (reference value) using repeatability data. For details of the minimum weighing value, refer to the technical information on our website. (<https://www.aandd.jp>)

6-2-1 With Balance Software Version 1.200 To Version 1.220

1. Press and hold the **MODE** key for 2 seconds in weighing mode.
2. Release the key when the **RESPONSE** display blinks.
3. **CH** appears, and the self check function starts. "ECL" will be displayed in a few seconds. If the **MODE** key is pressed with **CH** displayed, changes in weighing values in the repeatability measurement with the electronically controlled load (ECL) can be seen. (Available with balance software version 1.100 or later)

4. When the diagnosis is completed, the diagnosis result is displayed. If there are no problems inside the balance, **CH PASS** displays blinking. If **CH FAIL** displays blinking, there is a possibility that a fatal fault has occurred inside the balance. Please contact your local A&D dealer for repair.

SAMPLE key...Switches the display between diagnostic result, repeatability, and minimum weighing value (reference value).

PRINT key...Outputs the displayed content.

When repeatability is displayed, **OK** lights if catalog specifications are met. If catalog specifications are exceeded, **Err** displays blinking and a request for review of the installation environment is issued.

(Available with balance software version 1.100 or later)

5. Press the **CAL** key to display **End** and return to weighing mode.
6. To register as minimum weighing value of the minimum weight value display warning function, press the **RE-ZERO** key, which toggles between "No" and "Go". When **Go** is displayed, press the **PRINT** key. If you do not want to register, press the **PRINT** key with **No** displayed or press the **CAL** key to return to weighing mode.

* For minimum weighing warning function, refer to "15. Minimum Weighing Warning Function".

Note

With the balance software version 1.200, the self check function can only be executed when the login is made by Administrator (Admin) if the password lock function is ON.

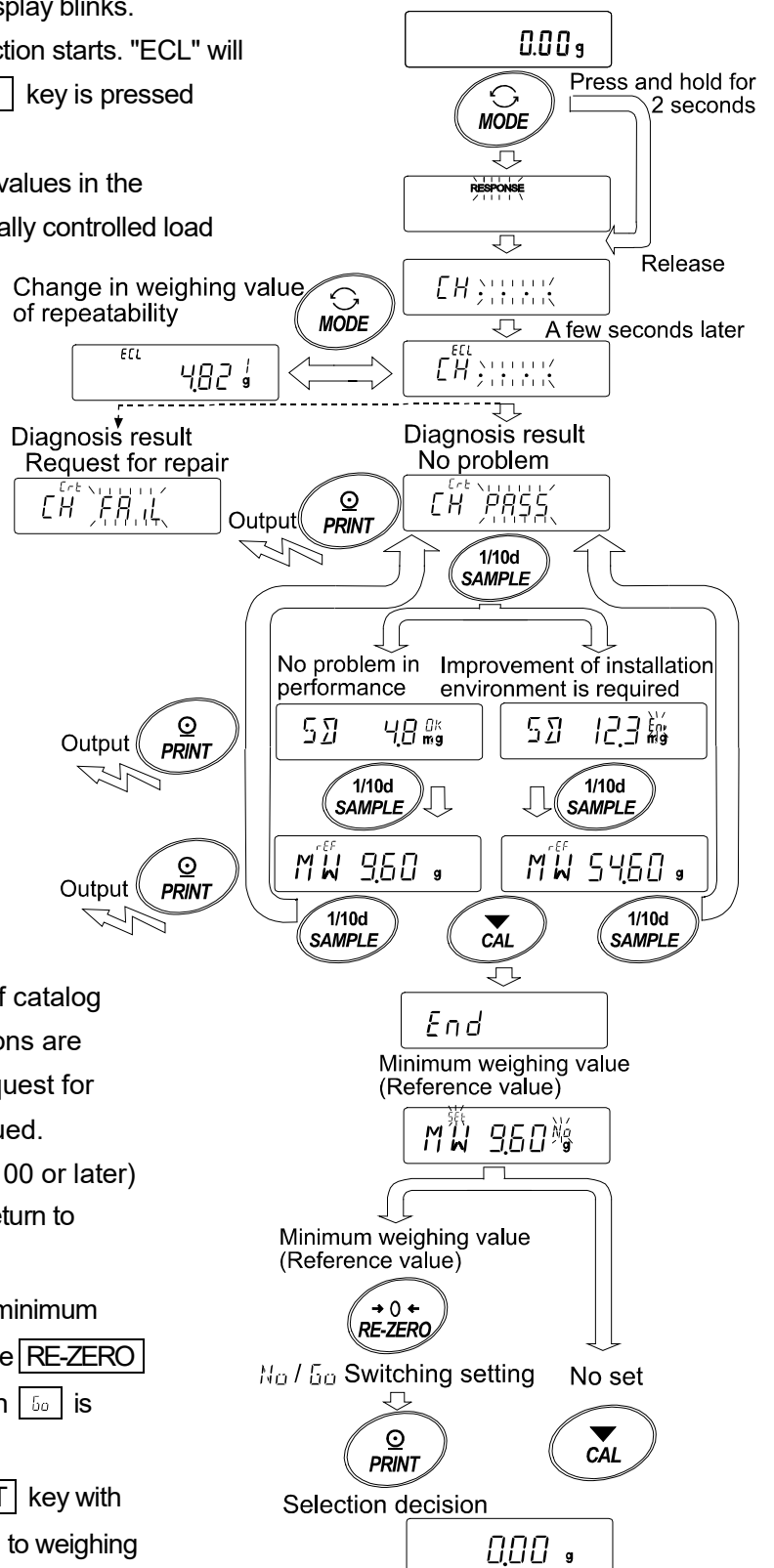

6-2-2 With Balance Software Version 1.300 or Later

Setting procedure (See also the setting procedure flowchart on the next page)

1. Press and hold the **MODE** key for 2 seconds in weighing mode.
2. Release the key when the **RESPONSE** display blinks.
3. **[CH:.....]** appears, and the self check function starts. "ECL" will be displayed in a few seconds. If the **MODE** key is pressed with **[CH:.....]** displayed, changes in weighing values in the repeatability measurement with the electronically controlled load (ECL) can be seen.
4. When the diagnosis is completed, the diagnosis result is displayed. If there are no problems inside the balance, the **[CH PASS]** displays blinking. If **[CH FAIL]** displays blinking, there is a possibility that a fatal fault has occurred inside the balance. Please contact your local A&D dealer for repair.

When repeatability is displayed, **OK** lights if catalog specifications are met. If catalog specifications are exceeded, **Err** displays blinking and a request for review of the installation environment is issued.

[SAMPLE] key·· Switches the display between diagnostic result, repeatability, and minimum weighing value (reference value).

[PRINT] key···· Outputs the displayed content.

[MODE] key···· Switches the measurement tolerance of the minimum weighing value (reference value).

With the minimum weighing value (reference value) displayed, the following operations can be performed with the keys.

5. Batch output of the minimum weighing value data
Press and hold the **[PRINT]** key for 2 seconds to display **[out]**. When batch output is completed, **[End]** will be displayed.
6. Registration of the minimum weighing value (reference value) described in "15. Minimum Weighing Warning Function"
Press and hold the **[SAMPLE]** key for 2 seconds to display **[MW SET]** and to register the minimum weighing value (reference value). When registration is completed, **[End]** will be displayed, and then the balance returns to weighing mode.
7. No registration
Press the **[CAL]** key to display **[End]**. The balance returns to weighing mode.
8. Diagnostic result display
Press the **[SAMPLE]** key to return to the diagnostic result display (step 4).

* For minimum weighing warning function, refer to " 15. Minimum Weighing Warning Function".

Setting procedure flowchart

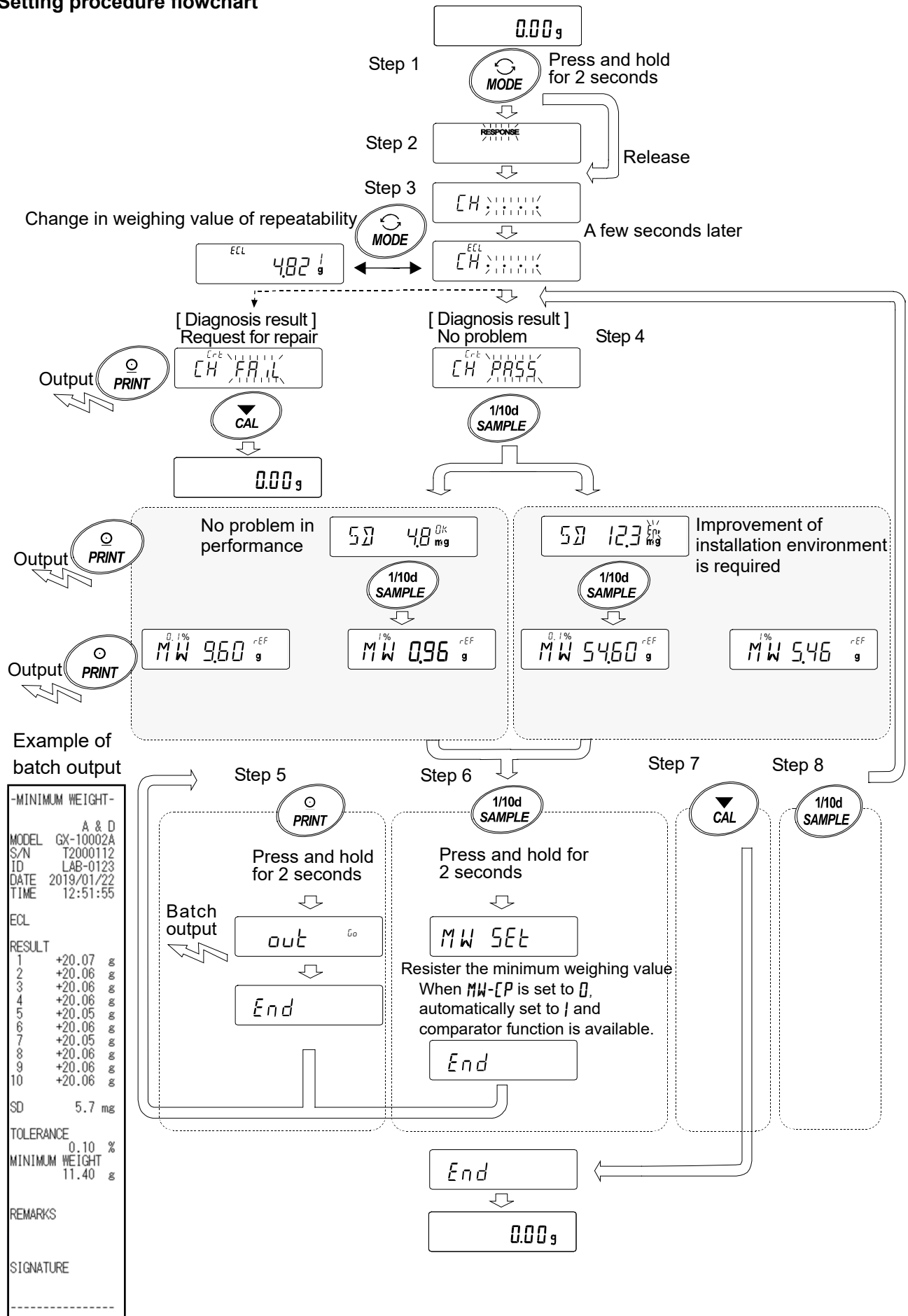

7. Sensitivity Adjustment / Calibration Test

Since the balance's resolution is high, weighing values may change due to gravity and daily environmental changes. It is necessary to perform sensitivity adjustment with the weight in order to keep the weighing values from changing even if gravity or the environment changes.

It is recommended that you perform sensitivity adjustment if the balance is installed for the first time or relocated, or when the weighing values change significantly in daily inspection, etc.

Sensitivity adjustment means to adjust the weighing value of the balance using the reference weight or internal mass. Calibration test is to weigh with the reference weight and compare how much the result deviates from the reference value. (Sensitivity adjustment is not performed in calibration test.)

Sensitivity adjustment

Automatic sensitivity adjustment	Automatically adjust the balance using the internal mass according to ambient temperature change, set time or interval time. (GX-AE/GX-A/GX-AWP series)
Sensitivity adjustment using the internal mass ...	Using the internal mass, adjust the balance with a single touch. (GX-AE/GX-A/GX-AWP series)
Sensitivity adjustment using an external weight...	Using an external mass, adjust the balance with an external mass.

Calibration test

Calibration test with an external weight	Output the result of checking the accuracy of weighing using your own weight. * No adjustment is made.
Calibration test with an internal mass	Output the result of checking the accuracy of weighing using the internal mass. * No adjustment is made. (GX-AE/GX-A series 0.0001g models)

Caution

- Do not allow vibration or drafts to affect the balance during sensitivity adjustment.
- To output the data for GLP/GMP using the RS-232C interface, set "GLP/GMP output (*INF*)" of "Data output (*OUT*)". Refer to "9. Function Table". The time and date can be added to the GLP/GMP report. If the time/date is not correct, you need to adjust it. Refer to "9-7 Clock and Calendar Function". The calibration test is a function that is active only when the output of maintenance records compatible with GLP/GMP, etc. is set.
- By setting "Data memory (*MEM*)" of the function table, the data of sensitivity adjustment report and calibration test report can be stored in memory.

Caution when using your external weight

- The accuracy of the weight used in sensitivity adjustment affects the accuracy of the balance after sensitivity adjustment.
- Select the mass to be used for sensitivity adjustment and calibration tests from the table below.

Model	Usable calibration weight	Factory setting	Adjustable range	
GX-124AE, GX-124A, GF-124A	50g, 100g	100g	-0.9999g ~ +0.9999g	
GX-224AE, GX-224A, GF-224A	50g, 100g, 200g	200g		
GX-324AE, GX-324A, GF-324A	50g, 100g, 200g, 300g			
GF-123A	50g, 100g	100g	-9.999g ~ +9.999g	
GX-203A, GX-203AWP	GF-203A GF-203AWP	50g, 100g, 200g		200g
GX-303A, GX-303AWP	GF-303A GF-303AWP	50g, 100g ~ 300g (100g interval)		200g
GX-403A, GX-403AWP	GF-403A GF-403AWP	50g, 100g ~ 400g (100g interval)		400g
GX-603A, GX-603AWP	GF-603A GF-603AWP	50g, 100g ~ 600g (100g interval)		500g
GX-1003A, GX-1603A	GF-1003A GF-1603A	50g, 100g ~ 1000g (100g interval)		1000g
GF-1202A	50g, 100g ~ 1600g (100g interval)	1000g		
GX-2002A, GX-2002AWP	GF-2002A GF-2002AWP	500g, 1000g, 2000g		2000g
GX-3002A, GX-4002A, GX-4002AWP	GF-3002A GF-4002A GF-4002AWP	500g, 1000g ~ 3000g (1000g interval)		
GX-6002A, GX-6002AWP	GF-6002A GF-6002AWP	500g, 1000g ~ 4000g (1000g interval)		
GX-10002A	GF-10002A	500g, 1000g ~ 6000g (1000g interval)		
GX-10002A	GF-10002A	500g, 1000g ~ 10000g (1000g interval)		
GX-6001A, GX-6001AWP	GF-6001A GF-6001AWP	500g, 1000g ~ 6000g (1000g interval)	5000g	-99.9g ~ +99.9g
GX-10001A	GF-10001A	500g, 1000g ~ 10000g (1000g interval)	10000g	

Display



This indicator means sensitivity adjustment data (sensitivity adjustment and calibration test) is being imported. Do not allow vibration or drafts to affect the balance while the indicator is displayed.

7-1. Automatic Sensitivity Adjustment (GX-AE/GX-A/GX-AWP Series Only)

This function automatically adjusts the sensitivity of the balance according to ambient temperature change, set time or interval time. It works even when the display is off. If GLP output is selected in the function table, the balance outputs the sensitivity adjustment report after the sensitivity adjustment.

- In the automatic sensitivity adjustment mode, the temperature change ([Fnc 0]), the set time ([Fnc 1]), or the interval time ([Fnc 2]) can be set with the function setting [Fnc].
- For the set time, three items, [TIME 1], [TIME 2] and [TIME 3], can be set in the function table.
- Interval time can be set from 0.5h to 24h with function setting [int].

Caution

If something is on the weighing pan, the balance itself will judge that it is in use and will not perform automatic sensitivity adjustment.

The criteria for performing automatic sensitivity adjustment are as follows.

0.0001g models	0.001g models	0.01g models	0.1g models
Lower than 0.5g	Lower than 2g	Lower than 20g	Lower than 20g

To maintain the accurately adjusted state, keep the weighing pan clear while not in use.

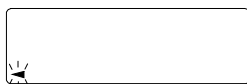

The automatic sensitivity adjustment notice (the ◀ mark blinking) indicates that the automatic sensitivity adjustment will start. If the balance is not in use, after blinking for a while, the balance will start automatic sensitivity adjustment using the internal mass. (The blinking duration depends on the environment.)

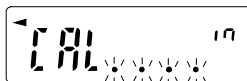

This indicates that the balance is importing sensitivity adjustment data. Do not allow vibration or drafts to affect the balance while this indicator is displayed. After sensitivity adjustment, the balance returns to the previous display.

Note

Although it is possible to continue using the balance even while the automatic sensitivity adjustment notice (the ◀ mark) is blinking, use after sensitivity adjustment is completed is advisable in order to maintain the weighing accuracy.

Depending on the setting of "8. Function Switch And Initialization", "Change prohibited" or "Changeable (usable)" can be selected.

7-1-1 Inputting The Set Time

1. Press and hold the **SAMPLE** key (for 2 seconds) to display **bASFnC**.
2. Press the **SAMPLE** key several times to display **Auto CAL**.
3. Press the **PRINT** key to display **[FnC]**.
4. With **[FnC]** displayed, press the **RE-ZERO** key several times to display **[FnC] t.ME**.
5. Press the **SAMPLE** key to display **[t.ME1]**.
6. Press the **PRINT** key to enter the set time 1 mode.
7. With **BFF ---:-- TMI** displayed, press the **RE-ZERO** key. The currently set time is displayed.
8. With the following keys, set the time (in 24-hour format) to perform sensitivity adjustment.
 - RE-ZERO** key (+) Changes the value of the selected (blinking) digit.
 - MODE** key (-)Changes the value of the selected (blinking) digit.
 - SAMPLE** keySelect the digit to blink.
 - PRINT** keyStores the new time setting.
 - CAL** keyCancels the new time setting.
9. Press the **PRINT** key to display **End**.
10. To set the set time 2, repeat the steps 6 to 9.
11. Press the **CAL** key twice to return to weighing mode.

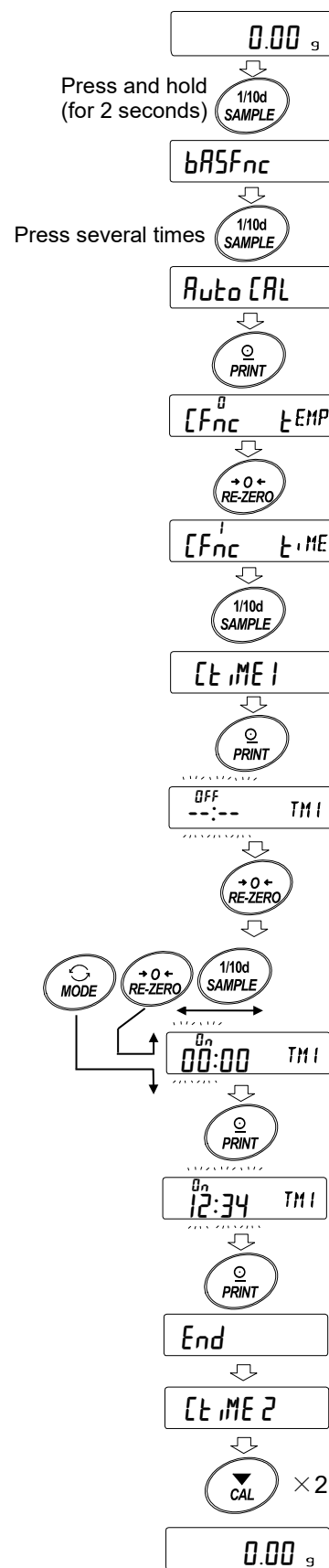

7-1-2 Clearing The Set Time

12. Refer to steps 1 to 5 of "Inputting the set time" on the previous page to display **CLIME1**.
13. Press the **PRINT** key to display the currently set time.
14. Press the **MODE** key to display **OFF --:-- TM1**.
15. Press the **PRINT** key to display **End**.
16. Press the **CAL** key twice to return to weighing mode.

Refer to steps 1 to 5 on the previous page

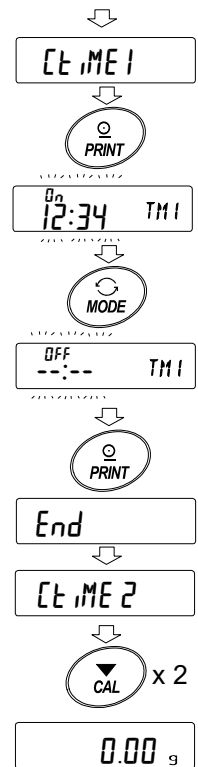

7-1-3 Setting The Interval Time

1. Press and hold the **SAMPLE** key (for 2 seconds) to display **bASFnC**.
2. Press the **SAMPLE** key several times to display **Auto CAL**.
3. Press the **PRINT** key to display **[FnC]**.
4. With **[FnC]** displayed, press the **RE-ZERO** key several times to display **[FnC² int]**.
5. Press the **SAMPLE** key to display **[int]**.
6. Press the **RE-ZERO** key several times to set the interval time (0.5 h to 24 h) to perform sensitivity adjustment. Refer to the correspondence table between set value and interval time.
7. Press the **PRINT** key to display **End**.
8. Press the **CAL** key to return to weighing mode.

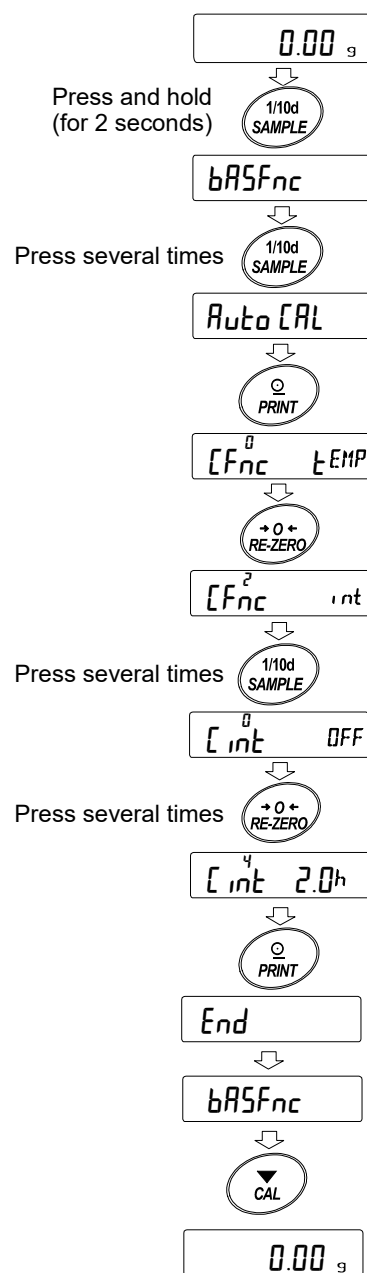

Correspondence table between the set value and interval time of the item “[int”.

Item	Parameter	Description
[int	0	Off
	1	0.5-hour interval time
	2	1.0-hour interval time
	3	1.5-hour interval time
	4	2.0-hour interval time
	5	2.5-hour interval time
	6	3.0-hour interval time
	7	3.5-hour interval time
	8	4.0-hour interval time
	9	4.5-hour interval time
	10	5.0-hour interval time
	11	5.5-hour interval time
	12	6.0-hour interval time
	13	7.0-hour interval time
	14	8.0-hour interval time
	15	9.0-hour interval time
	16	10.0-hour interval time
	17	11.0-hour interval time
	18	12.0-hour interval time
	19	14.0-hour interval time
	20	16.0-hour interval time
	21	18.0-hour interval time
	22	20.0-hour interval time
	23	22.0-hour interval time
	24	24.0-hour interval time

7-2. Sensitivity Adjustment Using The Internal Mass (GX-AE/GX-A/GX-AWP Series Only)

Sensitivity adjustment using the internal mass can be performed with one key press.

1. Connect the AC adapter and warm up the balance for at least 30 minutes with nothing on the weighing pan.
2. Press the **CAL** key. The balance displays **[CAL_{in}]**.
3. The balance performs sensitivity adjustment using the internal mass. Do not allow vibration or drafts to affect the balance.
4. After sensitivity adjustment, if GLP output (GLP) is set, a "sensitivity adjustment report" is output or stored to data memory.
5. The balance returns automatically to weighing mode.

About the internal mass

The value of the internal mass may change due to factors such as the operating environment and aging. Correct the internal mass value as necessary. Refer to "7-5 Correcting The Internal Mass Value Of The GX-AE/GX-A/GX-AWP Series", "7-5-1 Correcting The Internal Mass Value Of The GX-AE/GX-A/GX-AWP Series (Auto)", "7-5-2 Correcting The Internal Mass Value Of The GX-AE/GX-A/GX-AWP Series (Manual)".

Since the internal mass is about 190g, the possibility of error may increase as the weighing value increases.

To maintain the weighing accuracy, perform the sensitivity adjustment using an external weight periodically, as described in "7-3 Sensitivity adjustment Using An External Weight".

7-3. Sensitivity Adjustment Using An External Weight

This function adjusts the sensitivity of the balance using an external weight.

1. Connect the AC adapter and warm up the balance for at least 30 minutes with nothing on the weighing pan.
2. Press and hold the **[CAL]** key for 2 seconds until **[CAL out]** is displayed, then release the key.
3. Make sure that nothing is on the weighing pan and press the **[PRINT]** key to weigh the zero point. Do not apply vibration and the like.
4. Place the external weight on the weighing pan and press the **[PRINT]** key. Do not apply vibration and the like.
5. Remove the external weight from the weighing pan.
6. After sensitivity adjustment, if GLP output is set, a "sensitivity adjustment report" is output or stored to data memory.
7. The balance returns automatically to the weighing mode.
8. Place the external weight on the weighing pan again to check if it is within the set value ± 2 digits. If it is not within the range, start over from the first step of this procedure in the appropriate ambient conditions.

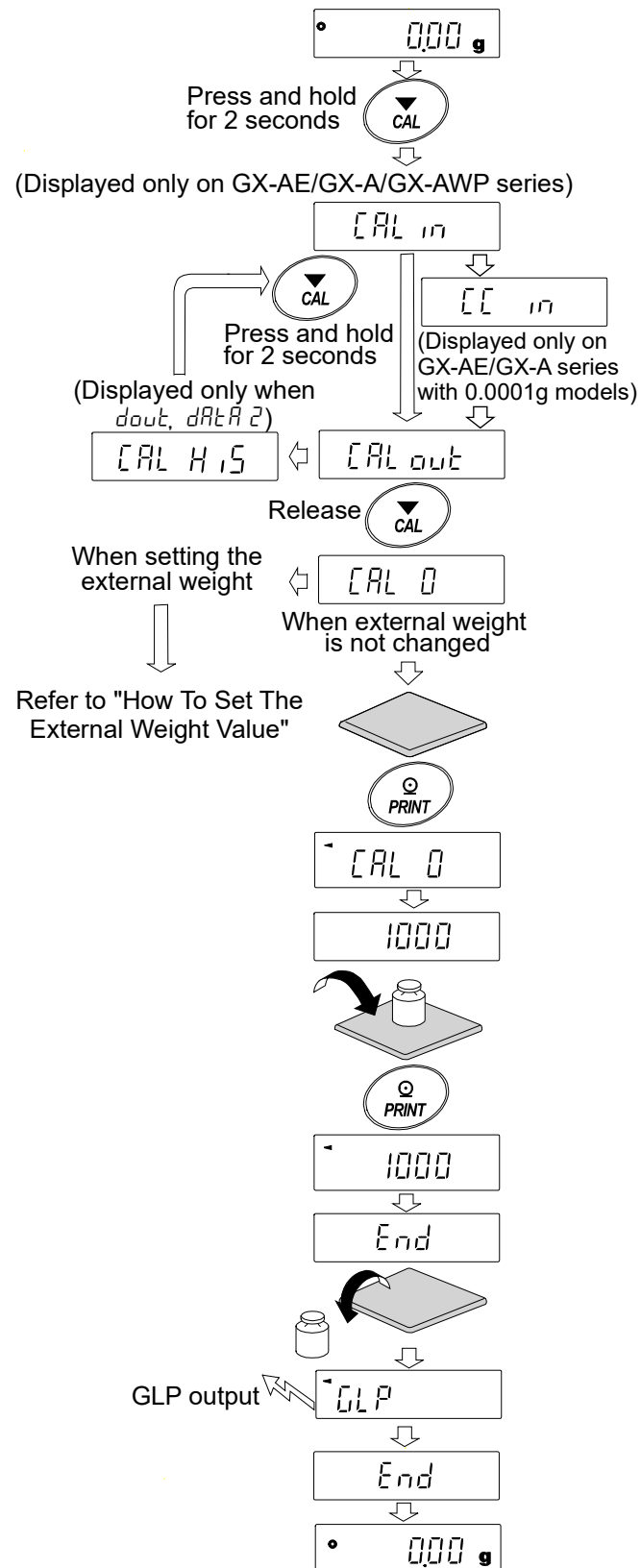

7-4. How To Set The External Weight Value

When performing sensitivity adjustment or calibration test, the external weight you have on hand can be set. (Refer to "Usable sensitivity adjustment weight" on page 41.)

After **[CAL 0]** is displayed the external weight value can be set as shown in "7-3 Sensitivity Adjustment Using An External Weight". Or, after **[CC 0]** is displayed, the external weight value can be set as shown in "7-7 Calibration Test Using An External Weight".

1. With the sensitivity adjustment display **[CAL 0]** or calibration test display **[CC 0]**, press the **[SAMPLE]** key.

2. Using the **[RE-ZERO]** key, select the external weight to use (refer to page 41) while all digits are blinking.

3. Set the external weight value with the following keys.

[SAMPLE] key…… Switches the display between "all digits blinking" (external weight selection mode) and "last four digits blinking" (instrumental error adjustment mode).

[RE-ZERO] key …(+) Changes the instrumental error. (When the digits reach positive 9999, negative 9999 appears next.)

[MODE] key ……(-) Changes the instrumental error. (When the digits reach negative 9999, positive 9999 appears next.)

[PRINT] key…… Registers the changed external weight value. Registered values are stored even when the power is turned off.

[CAL] key …… Suspends setting. (Returns to **[CAL 0]** or **[CC 0]**.)

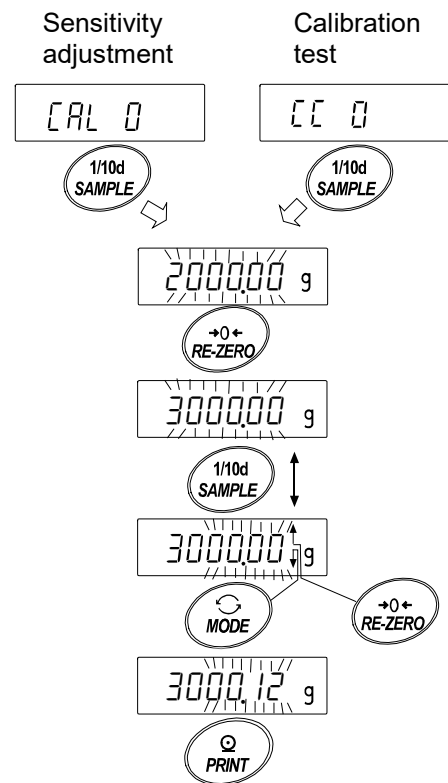

Example.
Updated the external weight
3000.12g

7-5. Correcting The Internal Mass Value Of The GX-AE/ GX-A/GX-AWP Series

Internal mass value correction can be performed with function setting [5].

There are two correction methods as follows.

Auto…… This is a method of correcting the internal mass weight value based on an external weight.

Manual…… This is a method of correcting by digitally inputting a correction reference value (internal weight conversion value).

Note

- Internal mass value correction cannot be performed by default.
Refer to "8. Function Switch And Initialization" or the following setting procedure and enable function setting change and internal mass value correction.

Setting procedure

1. Press the **ON:OFF** key to turn off the display.
2. While holding down the **PRINT** and **SAMPLE** keys, press the **ON:OFF** key to display **P5**.
3. Press the **PRINT** key and set the "internal mass correction switch" and "function setting switch" to "1" with the following keys.

SAMPLE key …… Selects the switch (the digit to blink).

RE-ZERO key …… Changes the value of the selected (blinking) switch.

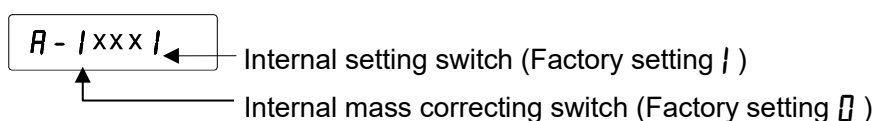

4. Press the **PRINT** key to register and display the weighing display.

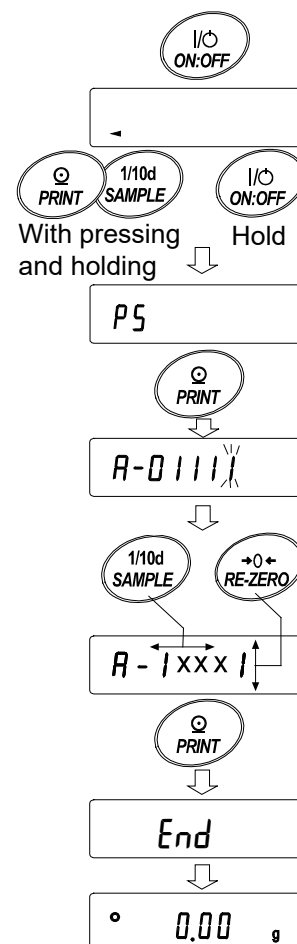

7-5-1 Correcting The Internal Mass Value Of The GX-AE/GX-A/GX-AWP Series (Auto)

Adjust the sensitivity of the balance referring to "7-3 Sensitivity Adjustment Using An External Weight".

This is method of correcting the internal mass value based on an external weight.

After sensitivity adjustment with the external mass, the balance automatically loads and unloads the internal mass and corrects the internal mass value.

The corrected mass value is stored in non-volatile memory even if the AC adapter is removed.

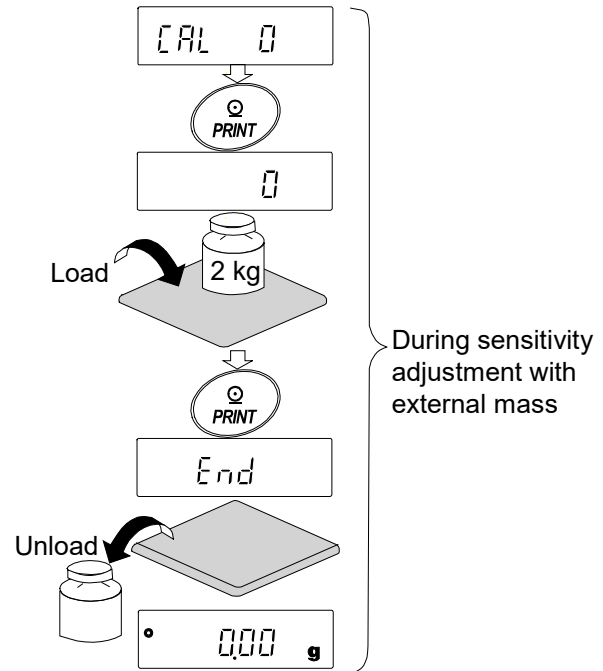

Setting procedure

The internal mass value correction cannot be performed by default. Refer to the setting procedure in "7-5 Correcting The Internal Mass Value Of The GX-AE/GX-A/GX-AWP Series" and enable function setting change and internal mass value correction.

1. In weighing mode, press and hold the **[SAMPLE]** key for 2 seconds to display **bASFnC**.
2. Press the **[SAMPLE]** key several times until **[5 in]** appears.
3. Press the **[PRINT]** key to display **Auto**.
4. Make sure there is no external disturbance, then press the **[PRINT]** key. **[CAL SET]** is displayed and correction of the internal mass value starts automatically.
5. When correction of the internal mass value is completed, **[CAL in]** is displayed and sensitivity adjustment with the corrected internal weight starts automatically.
6. When sensitivity adjustment is completed, **MANUAL** is displayed.
7. Press the **[CAL]** key twice to return to weighing mode.
8. Place the weight used for correction to confirm that the internal mass value is correctly adjusted. If it is not correctly adjusted, try again from the first step.
(Make sure there is no external disturbance during correction of the internal mass value)

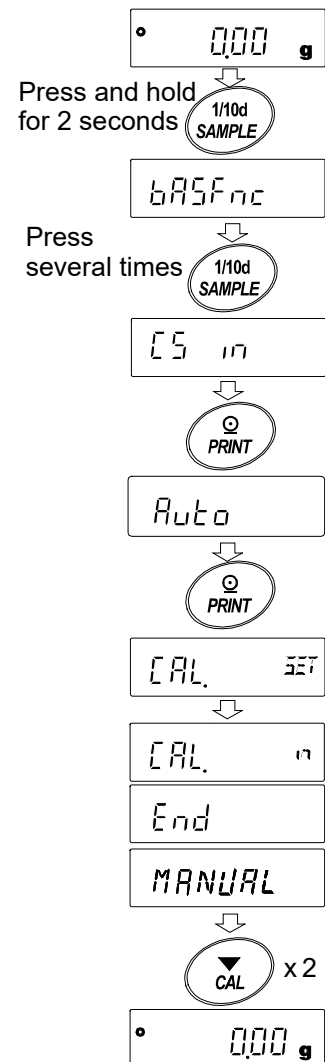

7-5-2 Correcting The Internal Mass Value Of The GX-AE/GX-A/GX-AWP Series (Manual)

The balance can correct the stored internal mass value within a certain range, and the value can be adjusted according to the weight you have. The correction reference value (internal mass conversion value) and correction range are as shown in the table below. The set value is stored in non-volatile memory even if the AC adapter is removed.

Model	Target	Range	Model	Target	Range		
GX-124AE	100.000g	±0.9999g	GX-203A, GX-203AWP	200.000g	±9.999g		
GX-124A			GX-303A				
GX-224AE	GX-403A, GX-403AWP						
GX-224A	200.0000g		GX-603A, GX-603AWP	500.000g			
GX-324AE			GX-1003A	1000.000g			
GX-324A	GX-1603A						
			GX-2002A, GX-2002AWP	2000.00g		±99.99g	
			GX-3002A				
			GX-4002A, GX-4002AWP	5000.00g			
			GX-6002A, GX-6002AWP				
			GX-10002A				
			GX-6001A, GX-6001AWP	5000.0g			±99.9g
			GX-10001A				

Example: GX-6002A

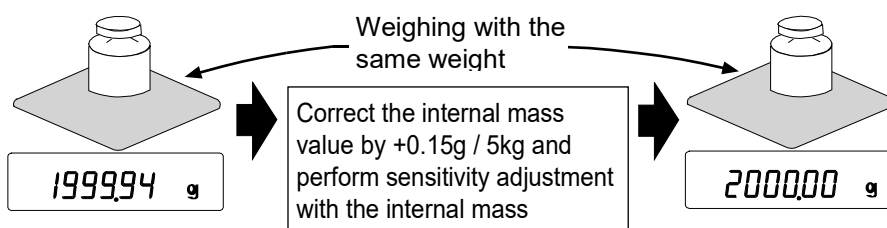

After performing sensitivity adjustment using the internal mass, place the external weight on the balance and check the correction amount.

(In the example, since there is deviation of -0.06g at 2000g, the correction amount for the GX-6002A is +0.15g/5kg because the correction target is 5000g.)

Setting procedure

The internal mass value correction cannot be performed by default. Refer to the setting procedure in "7-5 Correcting The Internal Mass Value Of The GX-AE/GX-A/GX-AWP Series" and enable function table change and internal mass value correction.

1. Press and hold the **SAMPLE** key for 2 seconds to display **bASFnC**.
(The balance enters the function table.)
2. Press the **SAMPLE** key several times until **[5 in** appears.
3. Press the **PRINT** key to display **Auto**.
4. Press the **SAMPLE** key to display **MANUAL** and then press the **PRINT** key.
Use the following keys to select.
 - RE-ZERO** key (+) ... Changes the correction value.
(When the digits reach positive 9999, negative 9999 appears next.)
 - MODE** key (-) Changes the correction value.
(When the digits reach negative 9999, positive 9999 appears next.)
 - PRINT** key Registers the value and displays the next item.
 - CAL** key Cancels the value and displays the next item.
5. Press the **CAL** key twice to return to weighing mode.
6. Press the **CAL** key to perform sensitivity adjustment with the internal mass.
7. Place the external weight on the weighing pan again to make sure the value is corrected.
If it is not, start over from the first step of this procedure. (Make sure there is no external disturbance during correction of the internal mass value)

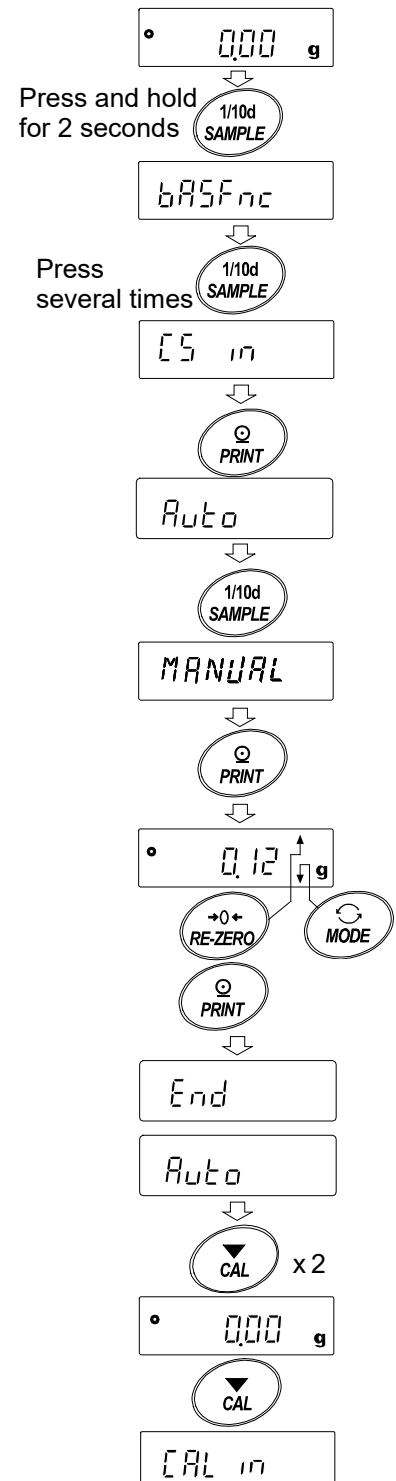

7-6. Calibration Test Using The Internal Mass (GX-AE/GX-A Series 0.0001g Models Only)

This function tests the weighing accuracy using the internal mass. (The result is output, but the sensitivity adjustment is not performed.)

The high-precision analysis models (0.0001g readability models) can perform calibration test.

1. Connect the AC adapter and warm up the balance for at least one hour with nothing on the weighing pan.
2. Press and hold the **[CAL]** key for 2 seconds until **[[[in]]** is displayed.
3. The zero point is checked. Do not apply vibration and the like.
4. The zero point checked is displayed.
5. Full scaling is checked. Do not apply vibration and the like.
6. The full scaling checked is displayed. The reference values by model are following. When the full scale display is within the measurement tolerance, it means that the sensitivity adjustment was performed correctly with the internal mass.

Model	Reference value of full scaling	Measurement tolerance
GX-124AE	100.0000g	±0.2mg
GX-124A		
GX-224AE	200.0000g	
GX-224A		
GX-324AE		
GX-324A		

7. When the output is set to GLP/GMP report (**inFD** / or **∫**), the calibration test result is output.
8. The balance automatically returns to weighing mode.

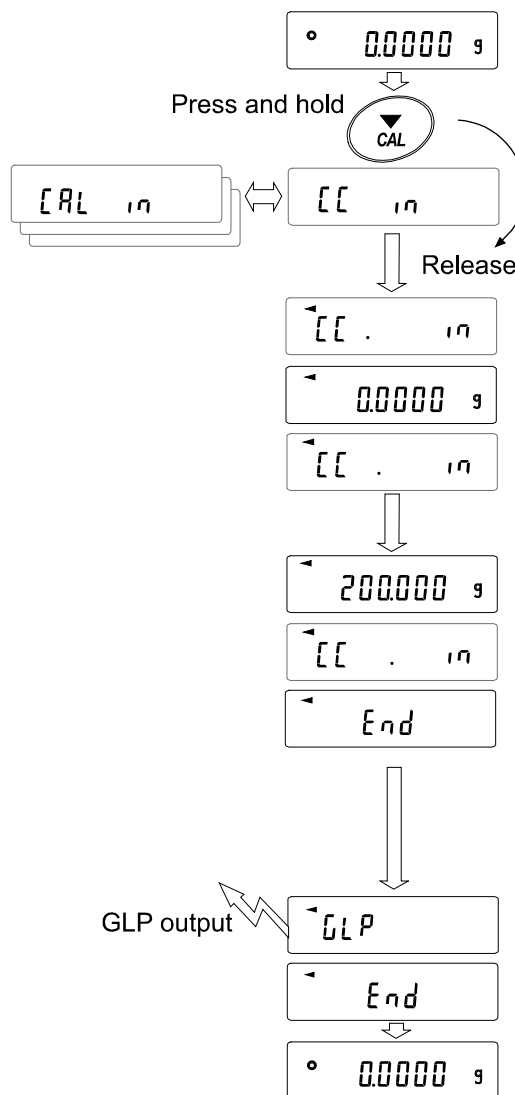

7-7. Calibration Test Using An External Weight

This function tests the weighing accuracy using an external weight and outputs the result. This is available only when the GLP/GMP output parameter is set (*dout, dAtA 2*). (Calibration test does not perform sensitivity adjustment)

1. Connect the AC adapter and warm up the balance for at least 30 minutes with nothing on the weighing pan.
2. Press and hold the **CAL** key for 2 seconds until **[[out** is displayed and release the key.
3. Make sure that nothing is on the weighing pan and press the **PRINT** key to weigh the zero point. Do not apply vibration and the like.
4. The weighing value of zero point is displayed for several seconds. Place the external weight on the weighing pan and press the **PRINT** key. The external weight is weighed. Do not apply vibration and the like.
5. Weighing value of the external weight is displayed for several seconds.
6. Remove the external weight from the weighing pan.
7. The calibration test report is output or stored in the data memory.
8. The balance automatically returns to weighing display.

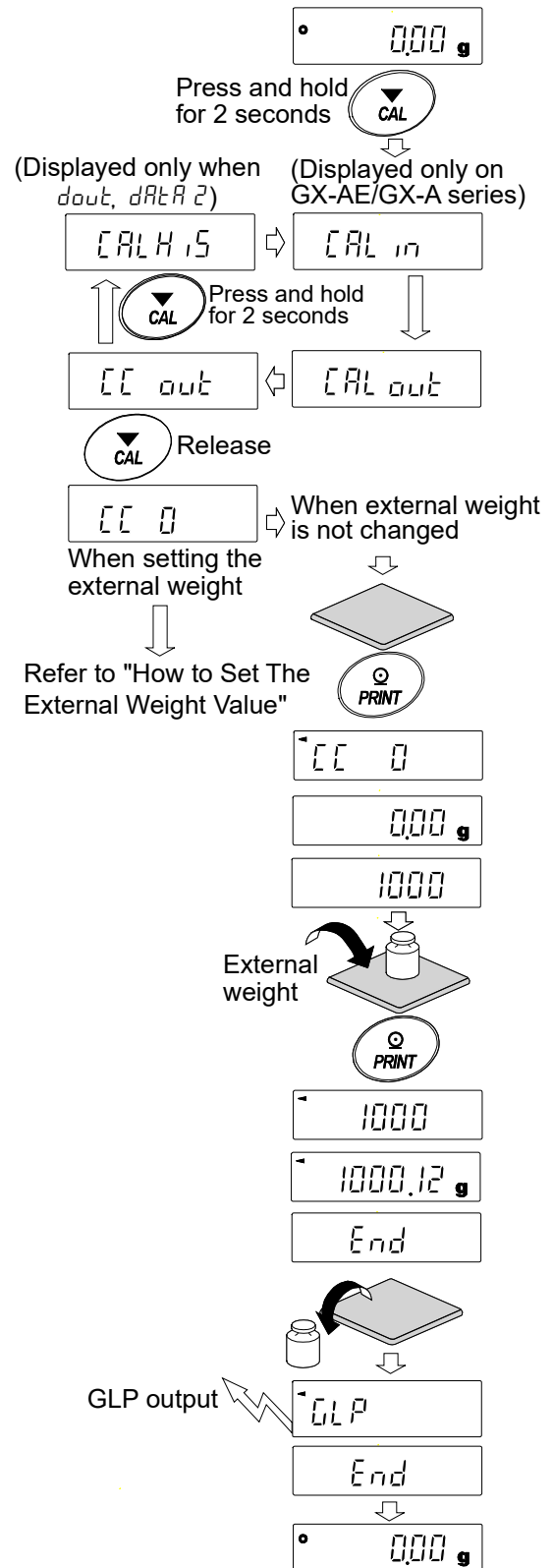

8. Function Switch And Initialization



8-1. Permit Or Inhibit

The balance stores data that must not be changed unintentionally (adjustment data for accurate weighing, data for adapting to the usage environment, data to control the communications interface, etc.). "Function selection switch" is provided to protect such data and to select "Change prohibited" or "Changeable (usable)". When "Change prohibited" is set, the function mode cannot be entered, so inadvertent change can be prevented.

There are five types of "Function selection switch":

"Function table", "Sensitivity adjustment using the internal mass", "Sensitivity adjustment using the external weight", "Automatic sensitivity adjustment", "Internal mass correction".

Setting procedure

1. Press the **ON:OFF** key to turn off the display.
2. While pressing and holding the **PRINT** key and the **SAMPLE** key, press the **ON:OFF** key to display **P5**.
3. Press the **PRINT** key to display "Function selection switch". Functions can be selected with the following keys.
 - SAMPLE** key..... Selects a switch to change the parameter. The selected switch blinks.
 - RE-ZERO** key Changes the parameter of the selected switch.
 -  Change prohibited
 -  Changeable (usable)
 - PRINT** key..... Stores the new parameter and returns to weighing mode.
 - CAL** key Cancels the operation (display **[Lr]**). Press the **CAL** key again to return to weighing mode.

Example of GX-AE/GX-A series

A-01111

The display shown left indicates the factory settings.

Function table

- 0 To inhibit changes to the function table.
- ! To permit changes to the function table.

Sensitivity adjustment using the internal mass

Balance software version 1.00 to 1.200

- 0 To inhibit sensitivity adjustment using the internal mass.
- ! To permit sensitivity adjustment using the internal mass.

Balance software version 1.211 or later

- 0 Lock 0 To inhibit sensitivity adjustment using the internal mass.
- Lock 1, 2 To inhibit sensitivity adjustment using the internal mass when logged in as User (USER 01 to 09) or Guest (GUEST). *1
- ! To permit sensitivity adjustment using the internal mass.

Sensitivity adjustment using an external weight

Balance software version 1.00 to 1.200

- 0 To inhibit sensitivity adjustment using an external weight.
- ! To permit sensitivity adjustment using an external weight.

Balance software version 1.211 or later

- Lock 0 To inhibit sensitivity adjustment using an external weight.
- Lock 1, 2 To inhibit sensitivity adjustment using an external weight when logged in as User (USER 01 to 09) or Guest (GUEST). *1

Automatic sensitivity adjustment

- 0 To inhibit automatic sensitivity adjustment.
- ! To permit automatic sensitivity adjustment.

Internal mass correction

- 0 To inhibit correction
- ! To permit correction

*1 This is available when logged in as Administrator (ADMIN).

Example of GF-A series

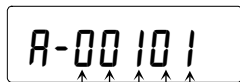

The display shown left indicates the factory settings.

Function table

- 0 To inhibit changes to the function table.
- 1 To permit changes to the function table.

No function

Sensitivity adjustment using an external weight

Balance software version 1.00 to 1.200

- 0 To inhibit sensitivity adjustment using an external weight.
- 1 To permit sensitivity adjustment using an external weight.

Balance software version 1.211 or later

- 0 Lock 0 To inhibit sensitivity adjustment using an external weight.
- Lock 1, 2 To inhibit sensitivity adjustment using an external weight when logged in as User (USER 01 to 10) or Guest (GUEST). *1

No function

No function

*1 This is available when logged in as Administrator (ADMIN).

8-2. Initializing The Balance

This function returns the following parameters to factory settings:

- Sensitivity adjustment data
- Function table, sample unit mass value (counting mode), 100% reference mass value (percent mode)
- Data stored in the balance with the data memory function
- External sensitivity adjustment weight value
- Function switch settings

Note Be sure to perform sensitivity adjustment after initializing the balance.

Setting procedure

1. Press the **ON:OFF** key to turn off the display.
2. While holding down the **PRINT** key and the **SAMPLE** key, press the **ON:OFF** key to display **P5**.
3. Press the **SAMPLE** key to display **[Lr]**.
4. Press the **PRINT** key.
(To cancel, press the **CAL** key.)
5. Press the **RE-ZERO** key to toggle between "No" and "Go".
6. With **[Lr Go]** displayed, press the **PRINT** key to perform initialization. When initialization is completed, the balance automatically returns to weighing mode.

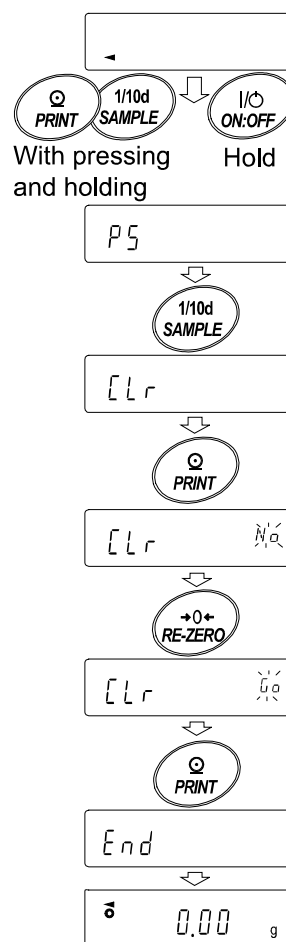







9. Function Table

The function table reads or rewrites the parameters that are stored in the balance. These parameters are stored in non-volatile memory, even if the AC adapter is removed.

The function table menu consists of two layers. The first layer is the "Class" and the second layer is the "Item".

9-1. Setting The Function Table

Display symbol and keys

	The symbol "o" shows that the parameter is enabled.
	When pressing and holding the key for 2 seconds in the weighing mode, the balance enters the function table mode. The key to select the class or item in the function table mode.
	The key to change the parameter.
	The key to change the class or item.
	When a class is displayed, moves to an item in the class. When an item is displayed, stores the new parameter and displays the next class.
	When an item is displayed, cancels the new parameter and displays the next class. When a class is displayed, exits the function table mode and returns to the weighing mode.

Setting procedure

- In weighing mode, press and hold the **SAMPLE** key for 2 seconds until **bASFnC** is displayed.
- Press the **SAMPLE** key to select a class.
- Press the **PRINT** key to enter the class.
- Press the **RE-ZERO** key to change the parameter of the selected item.
- Press the **SAMPLE** key to select the item.
- To change other items of the same class, repeat steps 4 and 5.
To finish changing the parameters of the same class, proceed to step 7.
- To store the new parameters of the class, press the **PRINT** key. Then the next class is displayed.
To cancel the new parameters for the class, press the **CAL** key. Then the next class is displayed.
- To change parameters of another class, continue from step 2.
To finish changing parameters, press the **CAL** key to return to weighing mode.

Setting Example

This example shows how to set "Stores the weighing data and sensitivity adjustment history (DATA 2)" of "Data memory (DATA)", and "1 minute (INT 5)" of "Interval time (INT)".

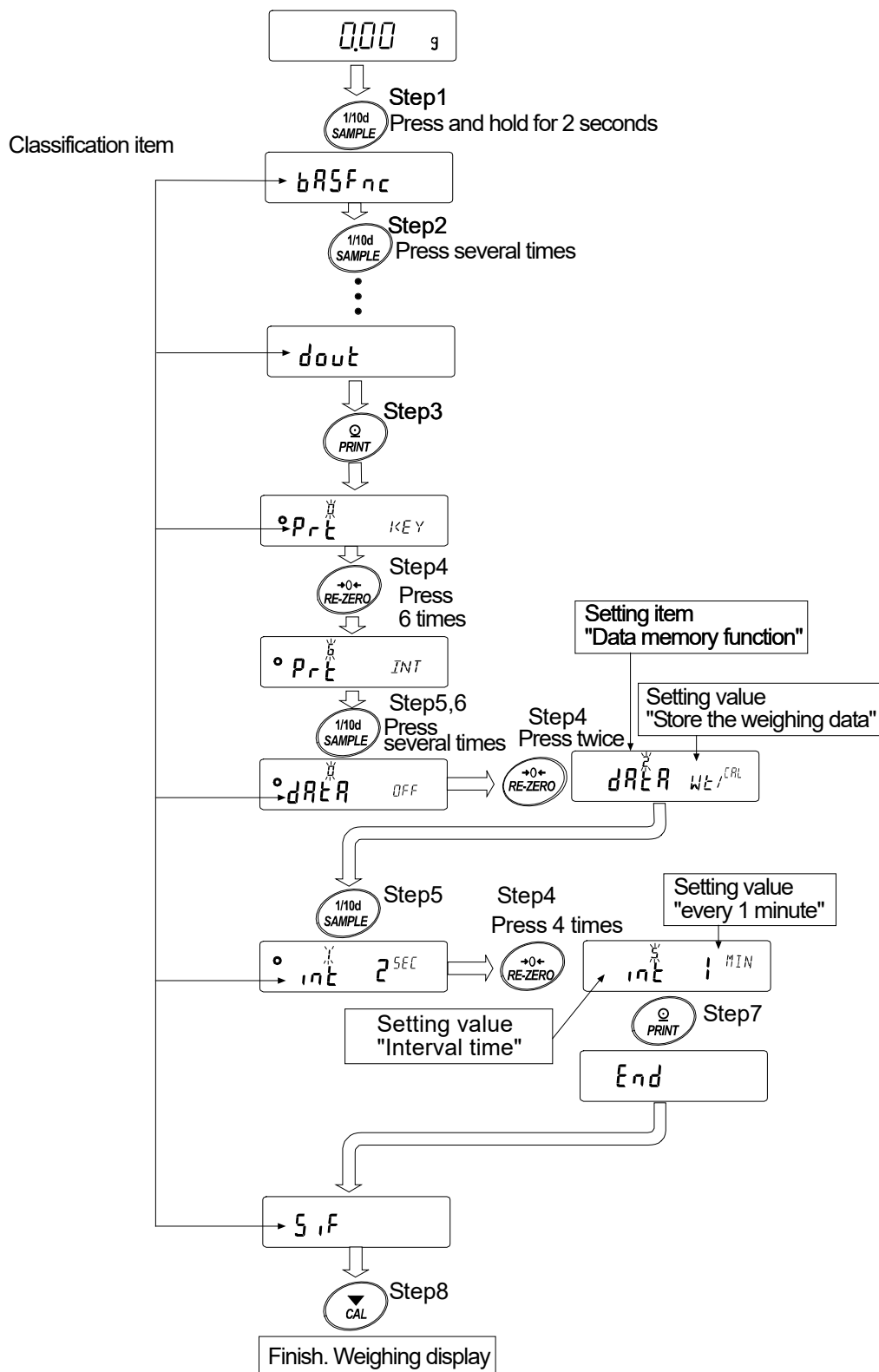

9-2. Details Of The Function Table

Class	Item	Parameter	Description		
<i>bRSFnC</i> [00] Environment Display	<i>Cond</i> Condition	0	Fast response, sensitive value	Can be changed by response adjustment. With "Hold 1", sets the averaging time.	
		▪ 1	↕		
		2	Slow response, stable value		
	<i>St-b</i> Stability band width	0	Stable when within ± 1 digit	The stabilization indicator illuminates with the display fluctuation within the range. With "Hold 1", sets the stabilization range.	
		▪ 1	↕		
		2	Stable when within ± 3 digit		
	<i>Hold</i> Hold function	▪ 0	OFF	Holds the display when stable in animal mode. With "Hold 1", <u>ANIMAL</u> turns on.	
		1	ON		
	<i>trc</i> Zero tracking	0	OFF	Keeps zero display by tracking zero drift.	
		▪ 1	Normal		
		2	Strong		
		3	Very strong		
	<i>SPd</i> Display refresh rate	▪ 0	5 times / second	Output frequency approx.5.21Hz	
		1	10 times / second	Output frequency approx.10.42Hz	
		2	20 times / second	Output frequency approx. 20.83Hz	
	<i>Pnt</i> Decimal point	▪ 0	Point (.)	Decimal point format	
		1	Comma (,)		
	<i>P-on</i> Auto display-ON	▪ 0	OFF	Turns on the weighing mode display when AC adapter is connected	
		1	ON		
	<i>P-off</i> Auto display-OFF	▪ 0	OFF	Turns off the display after 10 minutes of inactivity.	
1		ON			
<i>rnG</i> Readability	▪ 0	Display readability	Display at weighing start		
	1	Not display readability			
<i>bEEP</i> Buzzer	0	OFF	Buzzer sound such as key operation		
	▪ 1	ON			
<i>P-ZERO</i> Stores tare value	▪ 0	OFF Zero indication at power on	Previous time weighing indication at power on		
	1	ON			
<i>dISP-LED</i> Backlight brightness	0~9	10%~100%			
	▪ 5	Factory setting 60%			
<i>LV-LED</i> Bubble spirit level lightning	0	OFF	Bubble spirit level LED lightning		
	▪ 1	ON			
<i>ISd</i> Impact shock detection	0	OFF	Impact detection function (Valid for balance software version 1.300 or later)		
	▪ 1	ON			
<i>CL Add</i> [01] Clock		See "9-7 Clock And Calendar Function"		Confirms and sets the time and date. The time and date are added to output data.	

▪ Factory setting

Note: "Digit" is a unit of readability.

- The number in [] is the classification number. It is output as an identifier when outputting function table information in batch. Refer to "9-10 Output The Function Table Information".

Class	Item	Parameter	Description		
[02] [P Fnc Comparator	[P Comparator mode	0	No comparison		
		1	Comparison when stable value or overloaded		
		2	Continuous comparison		
	[P-t Number of comparator stages	0	3 stage comparator	HI, OK, LO	
		1	5 stage comparator	HH, HI, OK, LO, LL	
	[P-z Near zero	0	Also compare near zero		
		1	± 5 are not compared		
		2	± 10 are not compared		
		3	± 20 are not compared		
		4	± 50 are not compared		
		5	± 100 are not compared		
	[P-p Polarity	0	Plus only		
		1	Minus only		
		2	Bipolarity		
	[P in Input method	0	Digital input, upper / lower limits	[P HH, [P H1, [P L0	
		1	Weighing input, upper / lower limits	[P LL can be selected.	
		2	Digital input, reference value	[P rEF, [P LMe	
		3	Weighing input, reference value	[P LMe2 can be selected.	
[P-Frd Flow measurement	0	Comparison by flow rate value			
	1	Comparison by weighing value (g)			
[03] [P VALUE Comparator value	[P HH Second upper limit	See "9-8 Comparator Function"		Displayed only when [P in 0, 1 is set to digital input.	
	[P H1 Upper limit				
	[P L0 Lower limit				
	[P LL Second lower limit				
	[P rEF Reference value	See "9-8 Comparator Function"		Displayed only when [P in 2, 3 is set by input by load.	
	[P LMe Tolerance value				[P LMe2 is displayed only when 5 step comparator is set.
	[P LMe2 Second tolerance value				

■ Factory setting

Note: "Digit" is a unit of readability.

- The number in [] is the classification number. It is output as an identifier when outputting function table information in batch. Refer to "9-10 Output The Function Table Information".

Class	Item	Parameter	Description	
[04] <i>CP bEEP</i> Comparator buzzer	<i>bEP HH</i> HH buzzer	0	OFF	Displayed only when 5 step comparator is set.
		1	ON	
	<i>bEP HI</i> HI buzzer	0	OFF	
		1	ON	
	<i>bEP OK</i> OK buzzer	0	OFF	
1		ON		
<i>bEP LO</i> LO buzzer	0	OFF		
	1	ON		
<i>bEP LL</i> LL buzzer	0	OFF	Displayed only when 5 step comparator is set.	
	1	ON		
[05] <i>dout</i> Data output	<i>Prt</i> Data output mode *1	0	Key mode	Accepts the PRINT key only when the display is stable.
		1	Auto print mode A (Reference=zero)	Outputs data when the weighing value stabilizes beyond the range from $RP-P$ to $RP-b$ from the zero point.
		2	Auto print mode B (Reference=last stable value)	Outputs data when the weighing value stabilizes beyond the range from $RP-P$ to $RP-b$ from last stable value.
		3	Stream mode	Outputs data at the specified display refresh rate.
		4	Key mode B (Immediately)	Accepts the PRINT key regardless of the display condition.
		5	Key mode C (When stable)	Accepts the PRINT key immediately when the display is stable, or waits for the display to be stable when not.
		6	Interval output mode	Outputs data for each time set by <i>int</i> .
	$RP-P$ Auto print polarity	0	Plus only	Displayed value > Reference
		1	Minus only	Displayed value < Reference
		2	Bipolarity	Regardless of displayed value
	$RP-b$ Auto print difference	0	10 digit	Difference between reference value and displayed value
		1	100 digit	
		2	1000 digit	

■ Factory setting

Note: "Digit" is a unit of readability.

- The number in [] is the classification number. It is output as an identifier when outputting function table information in batch. Refer to "9-10 Output The Function Table Information".

*1 Download "Communication manual" from our website (<https://www.aandd.jp>) and refer to it.

Class	Item	Parameter	Description		
<i>dout</i> [05] Data output mode	<i>dMEm</i> Data memory	0	OFF	Refer to "11. Data Memory"	
		1	Stores unit mass in counting mode		
		2	Stores the weighing data and sensitivity adjustment history		
	<i>int</i> Interval time		0	Every measurement	Interval time in the interval memory mode when using <i>PrEt 6</i> .
			1	2 seconds	
			2	5 seconds	
			3	10 seconds	
			4	30 seconds	
			5	1 minutes	
			6	2 minutes	
			7	5 minutes	
	<i>d-no</i> Data number		0	No output	Valid when data memory function is ON.
			1	Output	
	<i>S-tD</i> Time/Date output		0	No output	Refer to "9-7 Clock And Calendar Function".
			1	Time only	
			2	Date only	
			3	Time and date	
	<i>S-id</i> ID number output		0	No output ID number	
			1	Output ID number	
	<i>PUSE</i> Date output pause		0	OFF	Selects the data output interval.
			1	ON open 1.6 seconds	
	<i>AL-F</i> Auto feed		0	OFF	Selects whether or not automatic feed is performed.
			1	ON open 1 line	
	<i>inFo</i> GLP output		0	OFF	Refer to "10-3 GLP Report"
			1	ON (output with internal clock)	
			2	ON (output with external clock)	
	<i>Ar-d</i> Zero after output		0	OFF	Function to apply re-zero after outputting data.
1			ON		
<i>UFC</i> *1 UFC function		0	OFF	Refer to "Communication manual" on the A&D website.	
		1	ON		

■ Factory setting

Note: "Digit" is a unit of readability.

- The number in [] is the classification number. It is output as an identifier when outputting function table information in batch. Refer to "9-10 Output The Function Table Information".

*1 Download "Communication manual" from our website (<https://www.aandd.jp>) and refer to it.

Class	Item	Parameter	Description		
5IF [06] Serial interface *1	Mode Connection	0	PC		
		1	Printer	TYPE 0, 1	
		2	External indicator	Stream output with TYPE 0	
	bPS Baud rate	0	600 bps		
		1	1200 bps		
		2	2400 bps		
		3	4800 bps		
		4	9600 bps		
		5	19200 bps		
		6	38400 bps		
	bPr Data bit, parity bit	0	7-bit EVEN		
		1	7-bit ODD		
		2	8-bit NONE		
	rLF Carriage return Line feed	0	CRLF		ASCII 0Dh code. CR
		1	CR		ASCII 0Ah code. LF
	YPE Data format	0	A&D standard format		Refer to "Communication manual" on A&D website.
		1	DP format		
		2	KF format		
3		MT format			
4		NU format			
5		CSV format			
6		NU2 format (Balance software version 1.415 or later)			
t-UP Timeout	0	Not limited		Select the wait time during command reception	
	1	Limited to 1 second			
ErEd AK Error Code	0	OFF		ASCII 06h code. AK	
	1	ON			
USB [07] Universal serial bus interface *1	UFnc USB function mode	0	Quick USB (Balance software version 1.211 or later)	The parameter settings depend on the balance software version. Refer to "Communication manual" on A&D website.	
		1	Bidirectional USB virtual COM (Balance software version 1.211 or later)		
	U-tP USB data format	0	A&D standard format		
		1	NU format		
		2	CSV format		
		3	TAB format		
4	NU2 format				

■ Factory setting

Note: "Digit" is a unit of readability.

- The number in [] is the classification number. It is output as an identifier when outputting function table information in batch. Refer to "9-10 Output The Function Table Information".

*1 Download "Communication manual" from our website (<https://www.aandd.jp>) and refer to it.

Class	Item	Parameter	Description		
[10] <i>APP Fnc</i> Application function	<i>APP</i> Application mode	0	Normal weighing mode		
		1	Capacity indicator		
		2	Statistical calculation mode		
		3	Flow measurement mode		
		4	Gross, Net, Tare mode		
	<i>STATF</i> Statistical function mode output items	0	Number of data, sum		
		1	Number of data, sum, max, min, range(max-min), average		
		2	Number of data, sum, max, min, range(max-min), average, standard deviation, coefficient of variation		
		3	Number of data, sum, max, min, range(max-min), average, standard deviation, coefficient of variation, relative error		
	<i>FRD Unit</i> Flow rate unit	0	g / s (gram/second)		Refer to "13. Flow Measurement"
		1	g / m (gram/minute)		
		2	g / h (gram/hour)		
		3	mL / s (milliliter/second)		
		4	mL / m (milliliter/minute)		
		5	mL / h (milliliter/hour)		
<i>Calc AUTO</i> Calculation time automatic setting	0	OFF			
	1	ON			
[11] <i>MW Fnc</i> Minimum Weighing Warning Function	<i>MW-CP</i> Minimum weighing comparison	0	No comparison Do not use MW Fnc		
		1	Comparison without near zero		
		2	Comparison including near zero		
	<i>MW</i> Minimum weighing value input	Refer to "15. Minimum Weighing Warning Function"			
	<i>MW-t</i> Minimum weight tolerance	0	0.10% (standard deviation SDx2000)		Refer to "15. Minimum Weighing Warning Function"
		1	1% (standard deviation SDx200 times)		
<i>Minout</i> Minimum weight out	0	OFF			
	1	ON			
[12] <i>Unit</i> Unit	Refer to "4. Weighing"				
[13] <i>dS Fnc</i> Specific gravity measuring function	<i>Ld in</i> Liquid density input	0	Water temperature		
		1	Liquid density		
	<i>dS</i> Specific gravity measuring mode	0	Density measurement of a soil		
		1	Density measurement of a liquid		
[14] <i>ALT</i> Programmable-unit (Multi-unit)	Sets an arbitrary coefficient. See "17. Programmable-Unit".		Available only when programmable-unit mode is selected.		
[15] <i>ID</i> ID number setting	Refer to "10-2 Setting The ID Number"				

■ Factory setting

Note: "Digit" is a unit of readability.

- The number in [] is the classification number. It is output as an identifier when outputting function table information in batch. Refer to "9-10 Output The Function Table Information".

Class	Item	Parameter	Description	
<i>PASSwd</i> [16] Password lock	<i>Lock</i> Lock function	■ 0	OFF	Refer to "19. Password Lock Function"
		1	ON (Limit weighing operation)	
		2	ON (Basic weighing is possible)	
	<i>PASSNo.</i> Password registration	<i>ADMIN</i>	Administrator password input	
		<i>USER 01</i> to <i>USER 10</i>	USER 1 password input USER 10 password input	
<i>Auto CAL</i> [17] Automatic sensitivity adjustment *2	<i>CFnc</i> Sensitivity adjustment mode	■ 0	Setting temperature	
		1	Setting time	
		2	Interval time	
	<i>[t iME1]</i> Setting Time1		Refer to "7-1 Automatic Sensitivity Adjustment (GX-AE/GX-A/ GX-AWP Series Only)"	
	<i>[t iME2]</i> Setting Time2			
<i>[t iME3]</i> Setting Time3				
<i>[int]</i> Interval time				
<i>Ion Fnc</i> [20] Ionizer function *3			Refer to the instruction manual of "GXA-17 Large Glass Breeze Break With Ionizer" from our website.	
<i>[5 in]</i> [18] Correction of internal mass value *2	<i>Auto</i>	Automatic input	Refer to "7-5-1 Correcting The Internal Mass Value Of The GX-AE/GX-A/ GX-AWP Series (Auto)"	
	<i>MANUAL</i>	Digital input of correction value	Refer to "7-5-2 Correcting The Internal Mass Value Of The GX-AE/GX-A/ GX-AWP Series (Manual)"	

■ Factory setting

Note. "Digit" is a unit of readability.

□ The number in [] is the classification number. It is output as an identifier when outputting function table information in batch. Refer to "9-10 Output The Function Table Information".

*2 GX-AE/GX-A/GX-AWP series only.

*3 GX-AE series only.

9-3. Description Of The Class Environment Display

Condition (ϵ_{ond})

$\epsilon_{ond} \emptyset$



$\epsilon_{ond} \text{?}$

This parameter is for sensitive response to the fluctuation of a mass value. Used for powder or liquid target mass, weighing a very light sample, or when quick response weighing is required. After setting to this, the balance displays **FAST**.

This parameter is for stable weighing with slow response. Used to prevent a mass value from drifting due to vibration or drafts. After setting to this, the balance displays **SLOW**.

Stability band width ($\zeta t-b$)

This item controls the width to regard a mass value as a stable value. When the fluctuation per second is less than the parameter, the balance displays the stabilization indicator and outputs or stores the data by function setting (*double dAtA*, etc.). The parameter influences the "Auto print mode". Also, the readability being displayed is 1 digit.

(E.g.) If 0.01 g display is selected by pressing the **SAMPLE** key on the GX-303A, 0.01 g is 1 digit.

$\zeta t-b \emptyset$



$\zeta t-b \text{?}$

This parameter is used for sensitive response of the stabilization indicator. Used for exact weighing.

This parameter ignores slight fluctuations of a mass value. Used to prevent a mass value from drifting due to vibration or drafts

Hold function (H_{oLd}) (Animal weighing mode)

This function is used to weigh a moving object such as an animal. When the weighing data is over the weighing range from zero and the display fluctuation is within the stabilization range for a fixed period of averaging time, the processing indicator illuminates and the balance displays the average weight of the animal. When the animal or sample is removed from the weighing pan, the display returns to zero automatically. This function is available only when the hold function parameter is set to "!" (the animal mode indicator **HOLD** illuminates) and any weighing unit other than the counting mode is selected. The stabilization range and averaging time are set in "Condition (ϵ_{ond})" and "Stability band width ($\zeta t-b$)".

Weighing range	
0.0001g model	0.0200g or more
0.001g model	0.200g or more
0.01g model	2.00g or more
0.1g model	20.0g or more

Averaging time	
$\epsilon_{ond} \emptyset$	2 sec. (for higher efficiency)
$\epsilon_{ond} !$	4 sec.
$\epsilon_{ond} \text{?}$	8 sec. (for higher accuracy)

Stabilization range		
$\zeta t-b \emptyset$	Lesser	6.25%
$\zeta t-b !$		12.5%
$\zeta t-b \text{?}$	Greater *	16.7%

* Animal weighing pan (GXA-12) can be attached to the models other than GX-203A, GX-124A, GX-224A, GX-124AE, GX-224AE, GF-203A, GF-124A, GF-224A, GX-203AWP and GF-203AWP.

Zero tracking (t_{rc})

This function tracks zero point drift caused by changes in the environment and stabilizes the zero point. The degree of tracking can be selected from 3 levels. If zero is not stable, increase the setting value. When the weighing data is only a few digits, turn the function off for accurate weighing.

- t_{rc} 0 The tracking function is not used. Used for weighing a very light sample.
- t_{rc} 1 The normal tracking function is used. (± 1 digit / 1 second)
- t_{rc} 2 The strong tracking function is used. (± 1 digit / 0.5 second)
- t_{rc} 3 The very strong tracking function is used. (± 1 digit / 0.2 second)

Display refresh rate (SP_d)

The periodic time to refresh the display. This parameter influences "Baud rate", "Data output pause" and the data output rate of "Stream mode".

Decimal point (P_{nt})

The decimal point format can be selected.

Auto display-ON (P_{-on})

When the AC adapter is plugged in, the display is automatically turned on without the ON:OFF key operation and the balance enters weighing mode. Used when the balance is built into an automated system. Half an hour warm up (more than one hour for 0.0001g models) is necessary for accurate weighing.

Auto power-OFF (P_{-off})

This is a function to automatically turn off only the display when there is no operation made for a certain amount of time (approximately 10 minutes) while the power is on.

Readability ($r_{n\bar{u}}$)

When weighing with rough precision, the readability can be turned off without key operation. This is useful when built into an automated system.

Buzzer ($bEEP$)

Select ON/OFF for the built-in buzzer that sounds when a key is operated or the status changes.

Tare value record ($P_{-T\bar{E}r\bar{d}}$)

After turning on the power supply, the display will not be automatically set to zero, and it will start from the previous weighing value. This is useful when a hopper, etc. is attached to the weighing pan and the power needs to be turned off while weighing discharge.

Backlight brightness ($d_{,SP-LEd}$)

Select the brightness of the backlight of the LCD display.

Bubble sprit level lightning ($L\bar{V}-LEd$)

Select ON/OFF for the LED that illuminates the bubble sprit level.

Impact shock detection ($,5d$)

Select ON / OFF for the function to display impact level.

* Applicable from balance software version 1.300 or later.

Even if the function to display impact level is turned off, it is recorded inside the balance when there is an impact.

9-4. Description Of The Data Output

Download "Communication manual" from our website (<https://www.aandd.jp>) and refer to it.

9-5. Description Of The Data Format

Download "Communication manual" from our website (<https://www.aandd.jp>) and refer to it.

9-6. Output Example Of The Data Format

Download "Communication manual" from our website (<https://www.aandd.jp>) and refer to it.

9-7. Clock And Calendar Function

The balance is equipped with a clock and calendar function. When the Clock and Calendar function (*clout, 5-td*) is set, the time and date are added to the output data.

Set or confirm the time and date as follows:

Operation

1. Press and hold the **SAMPLE** key for 2 seconds until **bASFnC** is displayed.
2. Press the **SAMPLE** key several times to display **CLAdj**.
3. Press the **PRINT** key.

The balance enters the mode to confirm or set the time and date.

Confirming the time

4. The current time is displayed with all the digits blinking.
 - To set the clock to the correct time, press the **RE-ZERO** key and go to step 5.
 - To confirm the date, press the **SAMPLE** key and go to step 6.
 - To finish setting, press the **CAL** key and go to step 8.

Setting the time

5. Set the time in 24-hour format using the following keys.
 - RE-ZERO** (+) key ··· Changes the value of the selected (blinking) digit.
 - MODE** (-) key ····· Changes the value of the selected (blinking) digit.
 - SAMPLE** key ····· Selects the digit to blink.
 - PRINT** key ······· Stores the new time setting and displays **End** and goes to step 6.
 - CAL** key ········· Cancels the new setting and goes to step 6.

Confirming the date

6. The current date is displayed with all the digits blinking.
 - To change the order of year [last two digits] (*Y*), month (*n*) and day (*d*), press the **MODE** key. The date will be output in the specified order.
 - To set the calendar to the correct date, press the **RE-ZERO** key to go to step 7.
 - To finish setting, press the **CAL** key to go to step 8.
 - To confirm the time again, press the **SAMPLE** key to go to step 4.

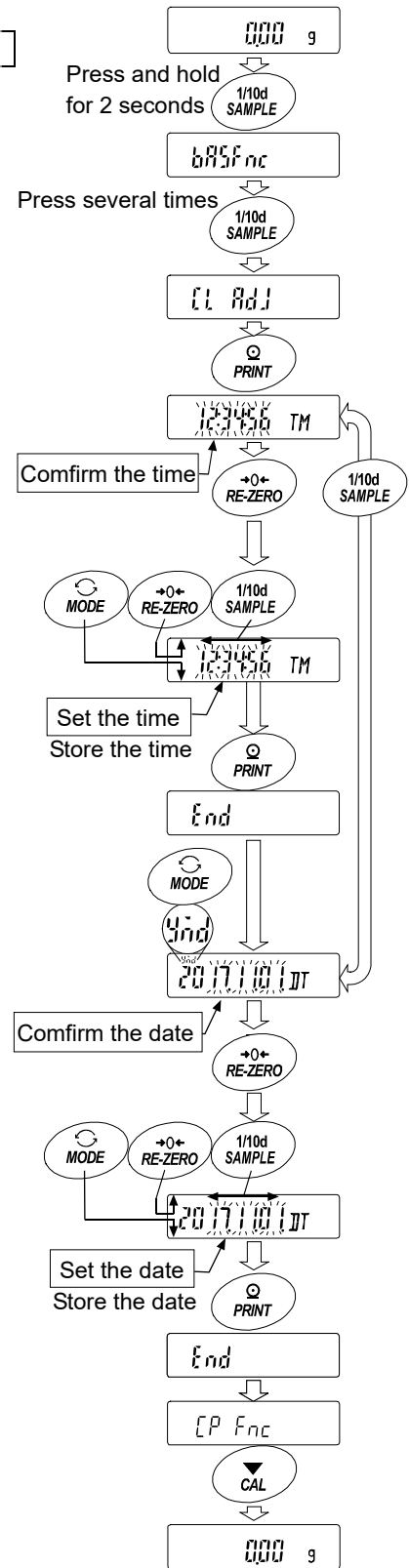

Setting the date

7. Set the date using the following keys. (The year is set with the last 2 digits of the year as per Western calendar)

RE-ZERO (+) key· Changes the value of the selected (blinking) digit.

MODE (-) key····· Changes the value of the selected (blinking) digit.

SAMPLE key····· Selects the digit to blink.

PRINT key····· Stores the new setting, displays **End**, and goes to step 8.

CAL key····· Cancels the new setting and goes to step 8.

Finishing setting

8. The balance displays the next menu (**[P Fnc]**) of the function table. Press the **CAL** key to exit the clock and calendar function and return to the weighing mode.

Note

Do not enter invalid values such as a non-existing date when setting the time and date.

The balance displays **[rLc PF]** when the clock backup battery has been depleted, but it only affects the clock and calendar function. The clock and calendar function works normally if the balance is powered with the AC adapter. Set the time and date using the keys.

9-8. Comparator Function

For comparison using the comparator function, either 3-stage or 5-stage can be selected ([P Fnc, [P-
t). The 3-stage comparator is selected by default, and the [HI] / [OK] / [LO] indicator will be displayed according to the result of comparison. When the 5-stage comparator is selected, HH and LL become available with the [HI] and [LO] indicators respectively displayed blinking.

With the optional GXA-04, comparison results can be output to the contact.

There are three operating ranges:

- No comparison
- Comparison when stable or overloaded
- Continuous comparison

There are six levels of conditions for comparing near zero, from "including near zero" to "± 100 digits". The criteria for comparison are "upper limit and lower limit value" and "reference value and tolerance range".

There are two ways to input the values: "digital input" and "input by sample load".

Refer to the function table [P Fnc].

With the function table [P bEEP], it is also possible to sound a built-in buzzer according to the comparison result.

3-stage comparison result

Weighing value		3-step comparison - display			
Threshold value	Judgment formula	Judgment result	Lit display	Blinking display	Buzzer control
Upper limit	Upper limit value < Weighing value	HI	[HI]		bEP HI
Lower limit	Lower limit value ≤ Weighing value ≤ Upper limit value	OK	[OK]		bEP OK
	Weighing value < Lower limit value	LO	[LO]		bEP LO

5-stage comparison result

Weighing value		5-step comparison - display			
Threshold value	Judgment formula	Judgment result	Lit display	Blinking display	Buzzer control
Second upper limit	Upper limit value < Weighing value	HH		[HI]	bEP HH
Upper limit	Upper limit value < Weighing value ≤ 2nd Upper limit value	HI	[HI]		bEP HI
Lower limit	Lower limit value ≤ Weighing value ≤ Upper limit value	OK	[OK]		bEP OK
Second lower limit	Lower limit value ≤ Weighing value < Lower limit value	LO	[LO]		bEP LO
	Weighing value < 2nd Lower limit value	LL		[LO]	bEP LL

Note

- In the flow measurement mode ([PF3]) by default, the comparator function makes comparison of flow rate values.
If [P-Frd of the Function table is set to [P Fnc "1", comparison of weighing values (g) is also possible.

Selecting the comparator (3-stage/5-stage)

1. Press and hold the **[SAMPLE]** key for 2 seconds until **bASFnC** of the function table is displayed.
2. Press the **[SAMPLE]** key several times to display **[P Fnc]**.
3. Press the **[PRINT]** key.
4. Press the **[SAMPLE]** key several times to display **[P-t]**.
5. Press the **[RE-ZERO]** key to select "0" for 3-stage comparator or "1" for 5-stage comparator. Press the **[PRINT]** key to set.
6. Press the **[CAL]** key to return to the weighing mode.

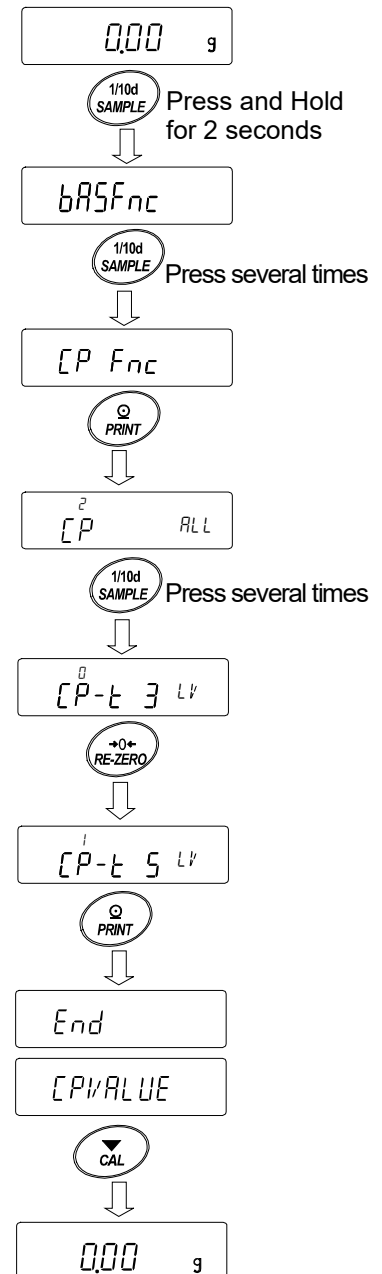

Setting example 1

Comparison when stable or overloaded. Upper/lower limits input.

Selecting a comparison method (operating range, comparison criteria, and value input) (Setup procedures starting from the factory default setting) (with the 3-stage comparator, comparison when stable or overloaded excluding near zero ± 10 digits, 1000.50g at maximum and 999.50g at minimum)

1. Press and hold the **SAMPLE** key for 2 seconds until **bRSFnC** of the function table is displayed.
2. Press the **SAMPLE** key several times to display **CP Fnc**.
3. Press the **PRINT** key.
4. Press the **RE-ZERO** key several times to display **CP** ("I" for continuous comparison).
5. Press the **PRINT** key to store the selected method.

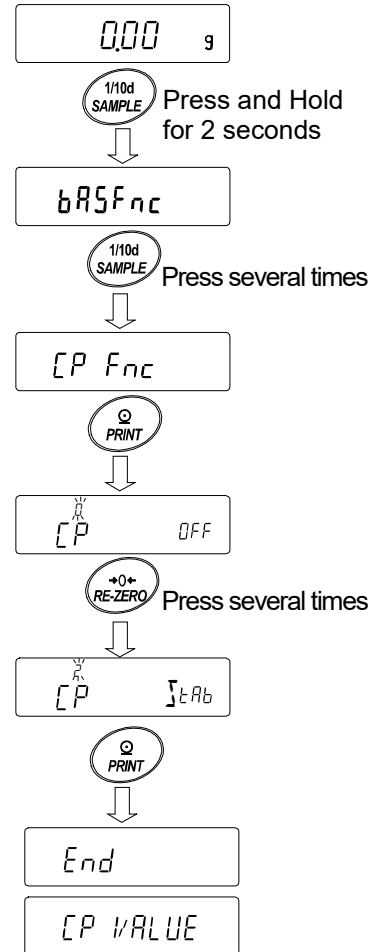

Entering the values

6. With **CP VALUE** displayed, press the **PRINT** key.
7. **CP H₁** appears.
8. Press the **PRINT** key.
9. The currently set value is displayed with all the digits blinking.
 - To continue with the set value, press the **PRINT** or **CAL** key to go to step 10.
 - To change the set value, press the **RE-ZERO** key. Use the following keys:
 - SAMPLE** key ... Selects the digit to change the value.
 - RE-ZERO** key · Changes the value of the selected digit.
 - MODE** key ... Reverses the polarity.
 - PRINT** key ... Stores the new value and goes to step 10.
 - CAL** key ... Cancels the new value and goes to step 10.
10. **CP Lo** appears.
11. Press the **PRINT** key.
12. The currently set value is displayed with all the digits blinking.
 - To continue with the set value, press the **PRINT** or **CAL** key to go to step 13.
 - To change the set value, press the **RE-ZERO** key. Use the following keys:
 - SAMPLE** key ... Selects the digit to change the value.
 - RE-ZERO** key · Changes the value of the selected digit.
 - MODE** key ... Reverses the polarity.
 - PRINT** key ... Stores the new value and goes to step 13.
 - CAL** key ... Cancels the new value and goes to step 13.
13. Press the **CAL** key twice to return to the weighing mode.

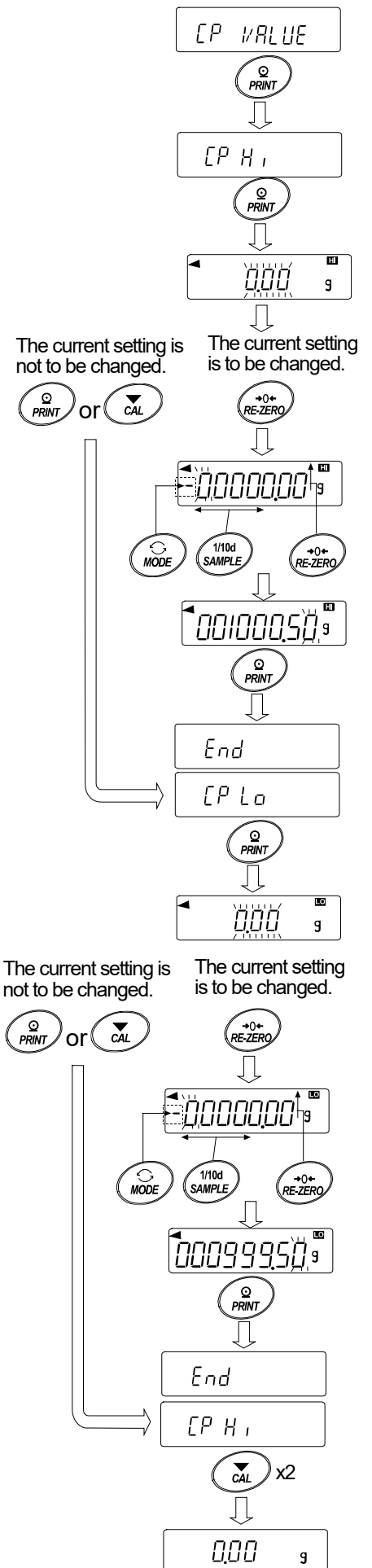

Setting example 2

Continuous comparison except near zero ± 20 digits. Reference / tolerance. Digital input.
 Selecting a comparison method (operating range, comparison criteria, and value input)
 (with the 3-stage comparator)

1. Press and hold the **[SAMPLE]** key for 2 seconds until **bASFnC** of the function table is displayed.
2. Press the **[SAMPLE]** key several times to display **[P Fnc]**.
3. Press the **[PRINT]** key.
4. Press the **[RE-ZERO]** key several times to display **[P ALL]** ("2" for continuous comparison).
5. Press the **[SAMPLE]** key several times to display **[P-2]**.
6. Press the **[RE-ZERO]** key several times to display **[P-2] Ex 20d** ("3" for ± 20 are not compared).
7. Press the **[SAMPLE]** key several times to go into the **[P in]** item.
8. Press the **[RE-ZERO]** key several times to display **[P in rFE DIG]** ("2" for reference value, digital input).
9. Press the **[PRINT]** key to store the selected method.

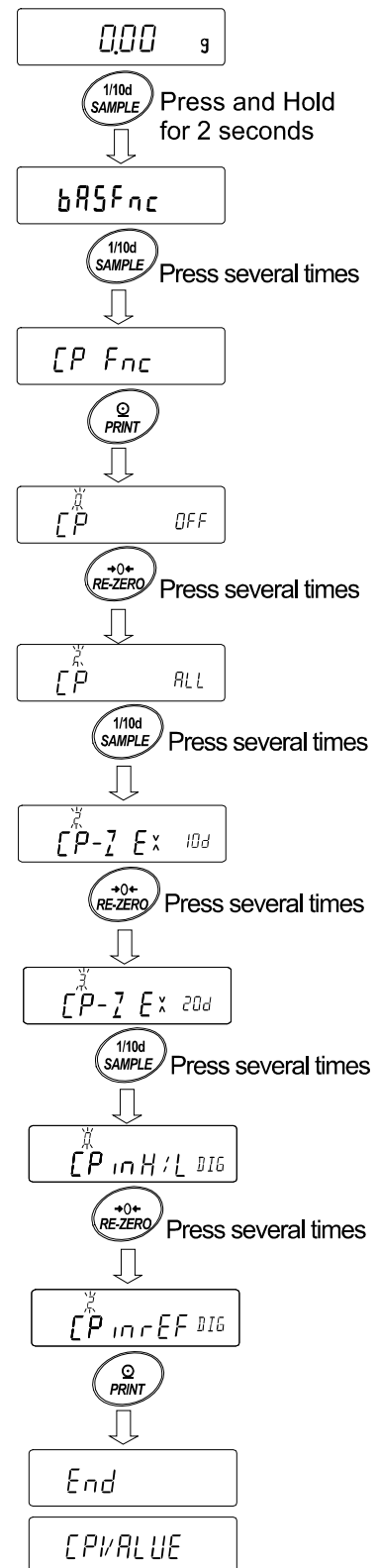

Entering the values

10. With **[CP VALUE]** displayed, press the **[PRINT]** key.
11. **[CP rEF]** appears.
12. Press the **[PRINT]** key.
13. The currently set value is displayed with all the digits blinking.
 - To continue with the set value, press the **[PRINT]** or **[CAL]** key to go to step 14.
 - To change the set value, press the **[RE-ZERO]** key. Use the following keys:
 - [SAMPLE]** key ··· Selects the digit to change the value.
 - [RE-ZERO]** key · Changes the value of the selected digit.
 - [MODE]** key ··· Reverses the polarity.
 - [PRINT]** key ··· Stores the new value and goes to step 14.
 - [CAL]** key ····· Cancels the new value and goes to step 14.
14. When **[CP LME]** is displayed, pressing the **[PRINT]** key displays the currently set value.

To change the set value, use the following keys and store a tolerance value.

For the tolerance range, enter a value with the reference value as 100%.

 - [SAMPLE]** key ····· Selects the digit to blink.
 - [RE-ZERO]** (+) key · Changes the value of the selected (blinking) digit.
 - [MODE]** (-) key ····· Changes the value of the selected (blinking) digit.
 - [PRINT]** key ······· Stores the new value and goes to step 15.
 - [CAL]** key ········· Cancels the new value and goes to step 15.
15. Press the **[CAL]** key twice to return to the weighing mode.

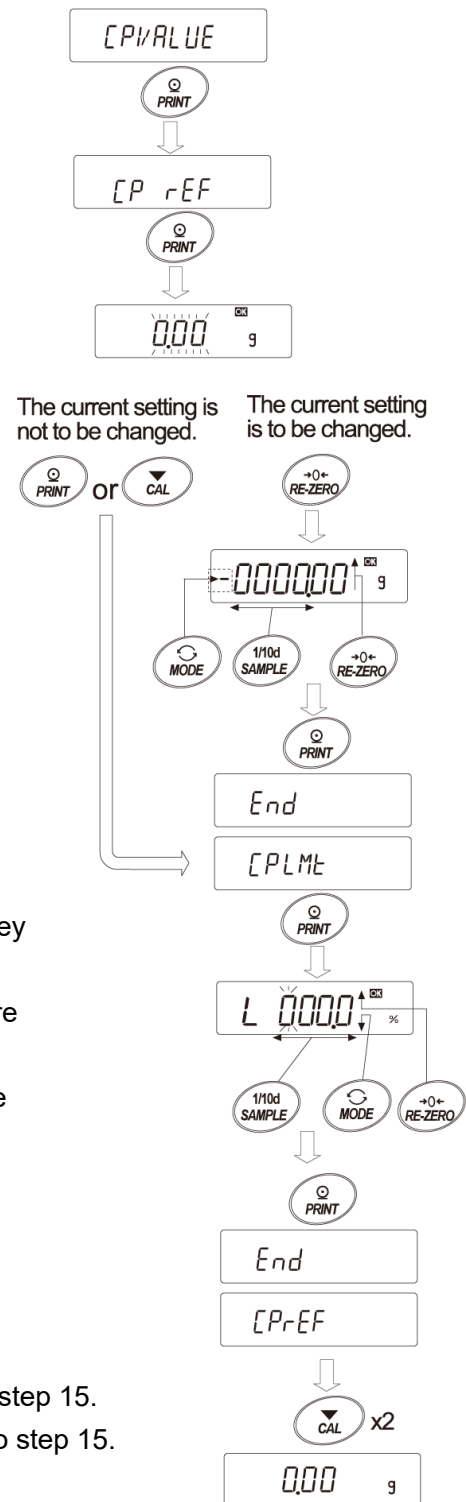

Setting example 3

Comparison when stable or overloaded including near zero. Upper/lower limits. Weighing input. Selecting a comparison method (operating range, comparison criteria, and value input) (with the 3-stage comparator)

1. Press and hold the **SAMPLE** key for 2 seconds until **bRSFnC** of the function table is displayed.
2. Press the **SAMPLE** key several times to display **[P Fnc]**.
3. Press the **PRINT** key.
4. Press the **RE-ZERO** key several times to display **[P]tRb** ("I" for comparison when stable or overloaded).
5. Press the **SAMPLE** key several times to display **[P-]**.
6. Press the **RE-ZERO** key several times to display **[P-]IH** ("0" for also compare near zero).
7. Press the **SAMPLE** key several times to display **[P in]**.
8. Press the **RE-ZERO** key several times to display **[P in H/LWT]** ("I" for weighing input, upper/lower limits).
9. Press the **PRINT** key to store the new setting.

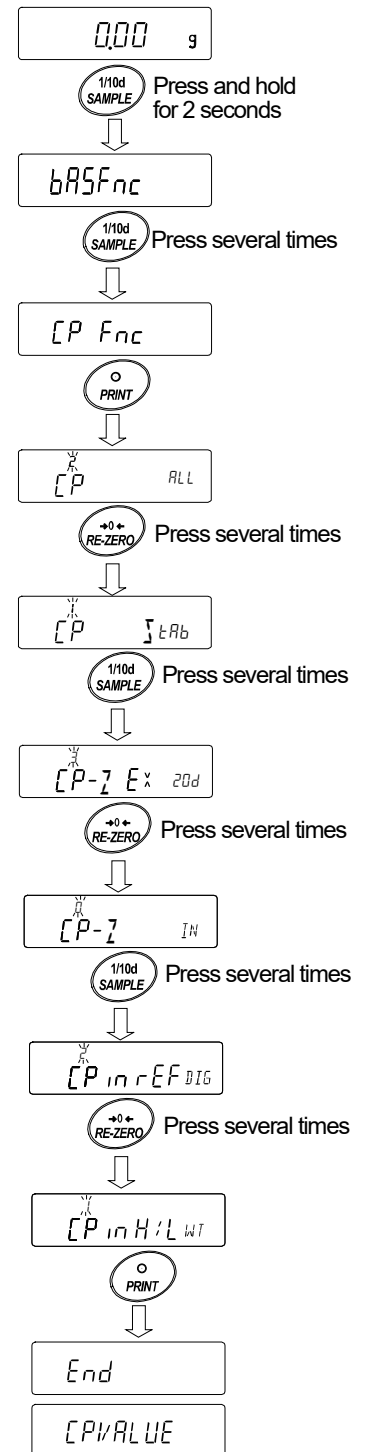

Entering the reference and tolerance values

10. When **[CPVALUE]** is displayed, press the **[PRINT]** key to display **[CPH_i]**.
11. When **[CPH_i]** is displayed, press the **[PRINT]** key to check the currently set value (all digits blinking). Press the **[RE-ZERO]** key to enter the load input mode.
12. Press the **[RE-ZERO]** key, **[0.00 g]** is displayed. Place a sample of the weight of the upper limit on the balance and press the **[PRINT]** key. (Register the upper limit value.)
13. When finished, **[CPLo]** is displayed. (Replace a sample of the weight of the upper limit from the balance.)
14. When **[CPLo]** is displayed, press the **[PRINT]** key to check the currently set value (all digits blinking). Press the **[RE-ZERO]** key to enter the load input mode.
15. Press the **[RE-ZERO]** key, **[0.00 g]** is displayed.
16. Place a sample of the weight of the lower limit on the balance and press the **[PRINT]** key. (Register the lower limit value.)
17. When finished, **[CPH_i]** is displayed. (Replace a sample of the weight of the lower limit from the balance.)
18. Press the **[CAL]** key twice to return to the weighing display.

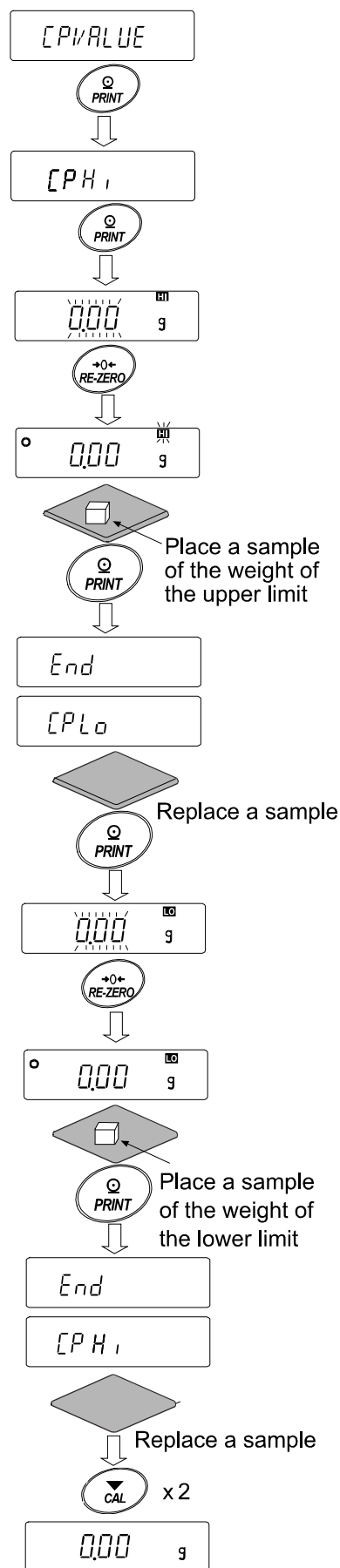

Sounding the built-in buzzer according to the comparison result.

1. Press and hold the **SAMPLE** key for 2 seconds until **bRSFnc** of the function table is displayed.
2. Press the **SAMPLE** key several times to display **CP bEEP**.
3. Press the **PRINT** key.
4. Press the **SAMPLE** key to set ON/OFF of the buzzer sound for the comparison judgment result. When the 3-stage comparator is set, the following three options are available:
bEP H_i **bEP ok** **bEP Lo**.^{*}
 When the 5-stage comparator is set, the following five options are available:
bEP HH **bEP H_i** **bEP ok** **bEP Lo** **bEP LL**.^{*}
5. Press the **PRINT** key to store the buzzer sound settings for the comparison judgment results. After **End** is displayed, **dout** appears.
6. Press the **CAL** key to return to weighing mode.

SAMPLE key Selects the comparison judgment result.

RE-ZERO key Sets ON/OFF of the buzzer sound for the comparison judgment result.

PRINT key Stores the settings.

5. Press the **PRINT** key to store the buzzer sound settings for the comparison judgment results. After **End** is displayed, **dout** appears.

6. Press the **CAL** key to return to weighing mode.

^{*} Regarding the setting of the comparator stage **CP-t**, refer to "Selecting the comparator (3-stage and 5-stage)" on page 71.

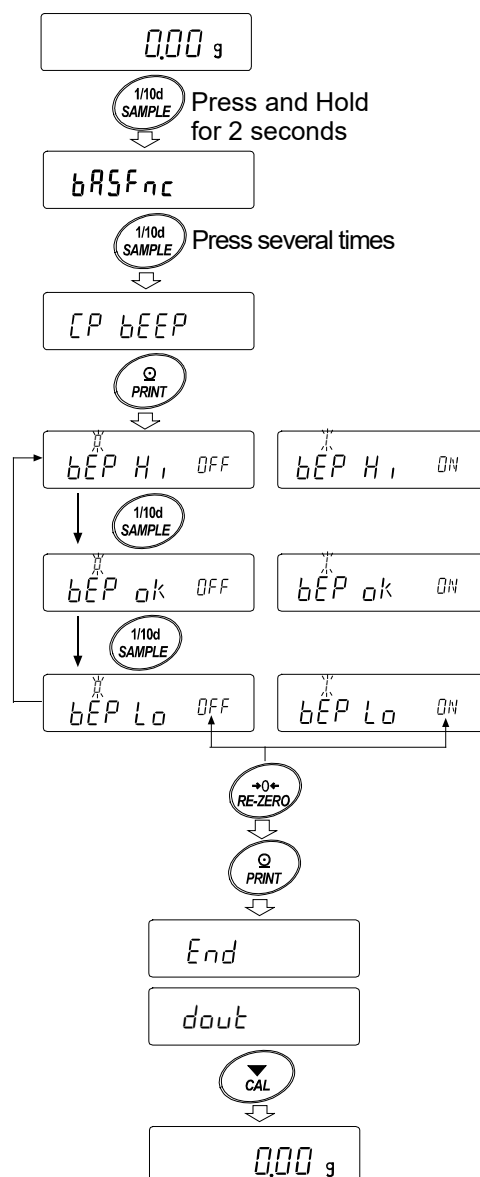

9-9. Description Of Application

Description of the normal weighing mode (APF 0).

This mode is set at the factory setting.

Description of the capacity indicator mode (APF 1).

In normal weighing, the weighing capacity indicator shows the relationship between the load and weighing capacity as a percentage.

(Zero 0%, weighing capacity 100%)

Note:

- It cannot be used when "dARA 1" or "dARA 2" of the data memory function (dARA) is set.

Description of the statistical calculation mode (APF 2).

This mode statistically calculates the weight data and displays/outputs the results.

For details, refer to "12. Statistical Calculation Mode".

Description of the flow measurement mode (APF 3).

This mode calculates the flow rate (change of weighing value with time).

For details, refer to "13. Flow Measurement".

Description of the gross, net, and tare mode (APF 4).

Zero setting and taring can be performed separately, and gross (total amount), net (net amount), and tare (tare amount) data can be output.

For details, refer to "14. Gross Net Tare Function".

9-10. Output The Function Table Information

With function table, you can set the balance's operation to that appropriate for how it is used. In the menu structure of the function table, setting items are included in each class, and a parameter is registered for each item. The function table information can be output in batch by the following operation so that the settings when the balance is used can be recorded.

Note

Available with balance software version 1.300 or later.

Procedure for batch outputting of function table information

1. Press and hold the **[SAMPLE]** key for 2 seconds in the weighing mode.
2. **bR5Fnc** is displayed.
3. Press and hold the **[PRINT]** key for 2 seconds. **-List-** appears and the current function table information is output in batch.

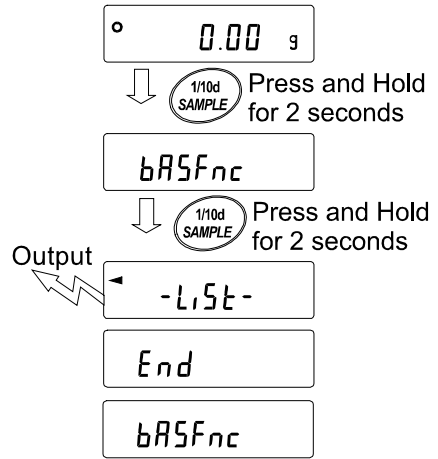

Example of output

```

A & D
MODEL  GX-324A ← Model name
S/N    12345678 ← Serial number
ID     LAB-0123 ← ID
DATE   2019/01/22 ← Date
TIME   16:29:35 ← Time } Outputs date and time of the balance
    
```

```

-----
Function Table
-----
00;Cond,01
00;St-b,01
00;HoLd,00
00;trc,01
00;SPd,00
00;Pnt,00
00;P-on,00
00;P-oFF,00
00;mG,00
00;bEEP,01
00;P-Zero,00
00;diSP-LEd,05
00;LV-LEd,01
00;iSd,01
-----
10;APF,00
10;StAF,00
10;Frd Unit,00
10;Ct AUto,00
-----
11;MW-CP,00
11;MW,00000.00 g
11;Min out,01
-----
16;Lock,00
-----
17;CFnc,00
17;Cint,00
-----
END
    
```

a. Class number (2 characters)
 b. Item (8 characters)
 c. Parameter (2 or 12 characters)
 *Divided by a comma.
 Refer to "9-2 Details Of The Function Table" for class numbers, items and parameters.

Output example 1 Outputting the function table settings to a printer

For printing, please use an AD-8127 multi-printer.

1. Connect the balance and the printer.

When using the AD-8127, set the print mode to "DUMP". For details about the settings and print mode, refer to the instruction manual of the printer. For connection between the balance and the printer, refer to "Communication manual" on A&D website (<https://www.aandd.jp>).

2. Make sure that communication is possible between the balance and the printer, and then perform the output operation according to the previous section "Procedure for batch outputting of function table information".

Output example 2 Outputting the function table settings to a computer

For USB setting and WinCT software, please refer to "Communication manual" and "WinCT Operation Manual" on our website (<https://www.aandd.jp>).

1. Connect the balance and a PC with the supplied USB cable or RS-232C cable (sold separately).

When using the USB, use it in the virtual COM mode. It is not possible to output with Quick USB.

2. Install WinCT software on the PC.

WinCT can be downloaded from our website (<https://www.aandd.jp>).

3. Start RSCom and match the communication settings such as COM port and baud rate with the balance. Clicking the [Start] button enables communication.
4. Make sure that communication is possible between the balance and the PC, and then perform the output operation according to the previous section "Procedure for batch outputting of function table information".

10. ID Number And GLP Report

10-1. Main Objective

- The data output compliant with "GLP/GMP" can be output to a personal computer or optional printer using the RS-232C serial interface.
- The GLP/GMP compliant report includes the balance manufacturer (A&D), model name, serial number, ID number, date, time, and space for signature. For a sensitivity adjustment or calibration test, the result and the weight used are also included.
- The balance can output the following GLP/GMP compliant reports via the RS-232C or USB.
 - Sensitivity adjustment report
(Output for sensitivity adjustment using the internal weight, automatic sensitivity adjustment, sensitivity adjustment using the external weight)
 - Calibration test report
(Output for calibration test using the internal weight or external weight)
 - Breaks ("title block" and "end block") for easy management of a series of weighing data
- Changing the function table enables the balance to store sensitivity adjustment report and calibration test temporarily in data memory in order to output all at once. For the setting, refer to "11. Data Memory".
- The ID number can be used as an identification number for the balance during maintenance of the balance.
- The ID number is stored in non-volatile memory even if the AC adapter is removed, and is valid until a new registration is made.
- For confirmation and setting of the time and date, refer to "9-7 Clock And Calendar Function".
- When printing GLP output with an AD-8127 multi-printer connected to the balance, the clock function of the printer can be used to print the time and date. (Function table "INF 2")
(Balance software version 1.211 or later)
Centralized management using the password lock function on the AD-8127 side is effective in preventing time and date tampering.

Note

To output GLP/GMP compliant reports, set the print mode of the AD-8127 to the dump print mode. If the external key print mode is set for weighing value printing, press and hold the ENT key of the AD-8127 for 2 seconds to switch between the external key print mode and dump print mode.

10-2. Setting The ID Number

1. Press and hold the **SAMPLE** key for 2 seconds until **bASFnC** of the function table is displayed.
2. Press the **SAMPLE** key several times to display **_id**.
3. Press the **PRINT** key. Set the ID number using the following keys.
 - SAMPLE** key..... Selects the digit to blink.
 - RE-ZERO** key, **MODE** key... Changes the character of the selected (blinking) digit.
 - PRINT** key..... Stores the new ID number and displays **PASSwd**.
 - CAL** key..... Cancels the new ID number and displays **PASSwd**.
3. With **PASSwd** displayed, press the **CAL** key to return to weighing mode.

Note

There are four types of segment displays on the balance display.

For each type of segment display, refer to the display correspondence table below.

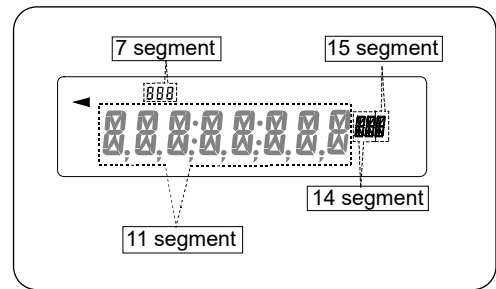

Display correspondence table

11 Segment

0	1	2	3	4	5	6	7	8	9	-	_	A	B	C	D	E	F	G	H	I	J	K	L	M	N	O	P	Q	R	S	T	U	V	W	X	Y	Z
0	1	2	3	4	5	6	7	8	9	-	_	A	B	C	D	E	F	G	H	I	J	K	L	M	N	O	P	Q	R	S	T	U	V	W	X	Y	Z

↳ Space

7 Segment

0	1	2	3	4	5	6	7	8	9	-	_	A	B	C	D	E	F	G	H	I	J	K	L	M	N	O	P	Q	R	S	T	U	V	W	X	Y	Z
0	1	2	3	4	5	6	7	8	9	-	_	A	B	C	D	E	F	G	H	I	J	K	L	M	N	O	P	Q	R	S	T	U	V	W	X	Y	Z

↳ Space

14 Segment

0	1	2	3	4	5	6	7	8	9	-	_	A	B	C	D	E	F	G	H	I	J	K	L	M	N	O	P	Q	R	S	T	U	V	W	X	Y	Z
0	1	2	3	4	5	6	7	8	9	-	_	A	B	C	D	E	F	G	H	I	J	K	L	M	N	O	P	Q	R	S	T	U	V	W	X	Y	Z

↳ Space

15 Segment

0	1	2	3	4	5	6	7	8	9	-	_	A	B	C	D	E	F	G	H	I	J	K	L	M	N	O	P	Q	R	S	T	U	V	W	X	Y	Z
0	1	2	3	4	5	6	7	8	9	-	_	A	B	C	D	E	F	G	H	I	J	K	L	M	N	O	P	Q	R	S	T	U	V	W	X	Y	Z

↳ Space

10-3. GLP Report

To output GLP/GMP data and the like with an AD-8127 multi-printer or PC, set to "inF0 1" (output the clock data built into the balance) or "inF0 2" (output the clock data of the external device) in the function table.

Note

- If the date/time is incorrect with "inF0 1" (use the clock data built into the balance), adjust the date/time with "CL ADJ" (Clock) of the function table.
- "inF0 2" parameter setting is available with balance software version 1.211 or later.

Examples of sensitivity adjustment report using the internal mass

This is the GLP report when the sensitivity of the balance is adjusted using the internal mass.

- Output the clock data built into the balance ($\text{Fn} F_0 I$)

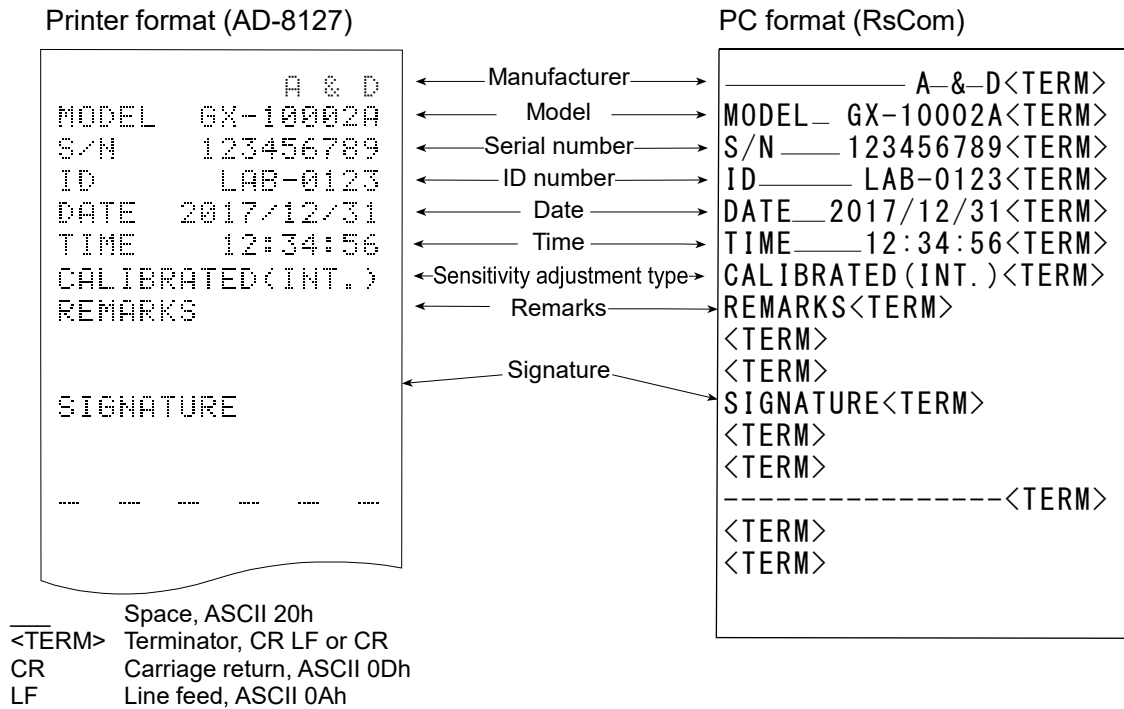

- Output the clock data of the external device ($\text{Fn} F_0 Z$).

When outputting data such as that for GLP/GMP, setting the function table " $\text{Fn} F_0 Z$ " enables use of the clock data of the external device such as a PC or printer instead of the clock data built into the balance. Use this function to unify clock data with the clock function of an external device.

Note

- The function to output the clock data of external devices can be used with devices that have a clock function and can output the date and time in response to <ESC>D and <ESC>T. (e.g. AD-8127 multi printer, RsCom [WinCT])
- For sensitivity adjustment history storage of the data memory function, the clock data built into the balance is saved even when " $\text{Fn} F_0 Z$ " is set.

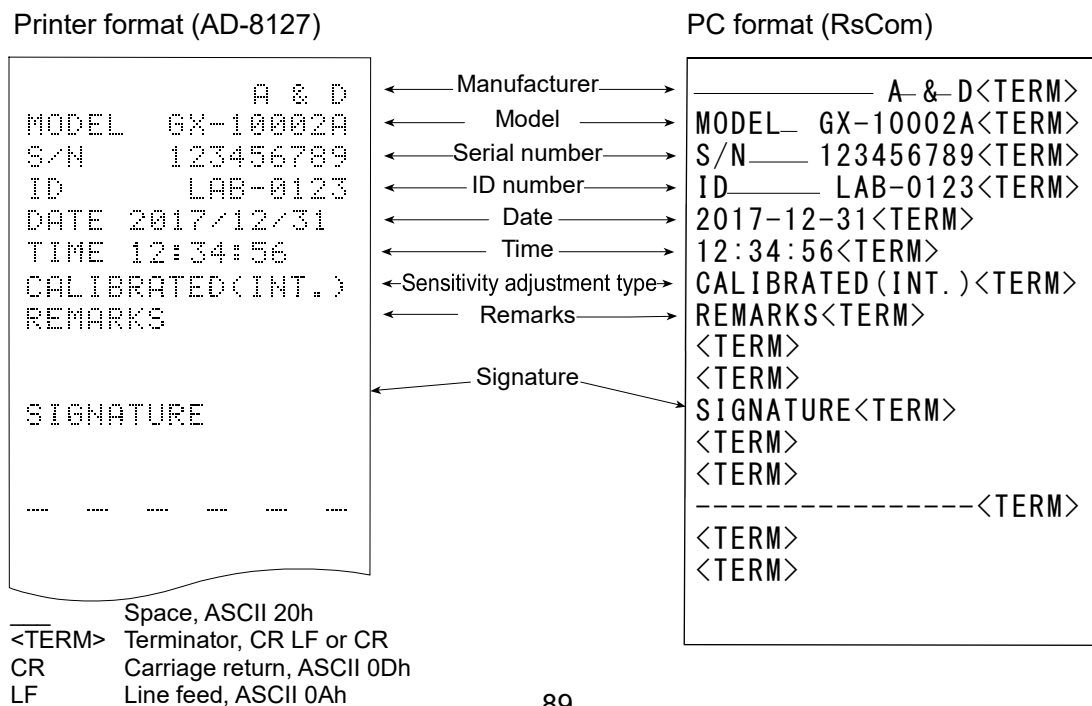

Calibration test report using the internal mass (0.0001g models only)

This is the GLP report when checking the weighing accuracy of the balance with the internal mass.

(Adjustment is not performed).

When "inF0!" is set.

Printer format (AD-8127)

```

                A & D
MODEL      GX-324A
S/N       123456789
ID        LAB-0123
DATE      2017/12/31
TIME      12:34:56
CAL.TEST<INT.>
ACTUAL
           0.0000 g
           +199.9999 g
TARGET
           +200.0000 g
REMARKS

SIGNATURE

-----
    
```

PC format (RsCom)

← Manufacturer →	_____ A_&_D <TERM>
← Model →	MODEL____GX-324A <TERM>
← Serial number →	S/N____123456789 <TERM>
← ID number →	ID_____LAB-0123 <TERM>
← Date →	DATE_2017/12/31 <TERM>
← Time →	TIME_____12:34:56 <TERM>
← Calibration test →	CAL. TEST (INT.) <TERM>
	ACTUAL<TERM>
← Zero point value →	_____0.0000_g <TERM>
← Target weight value →	_____+199.9999_g <TERM>
← Target weight →	TARGET <TERM>
	_____+200.0000_g <TERM>
← Remarks →	REMARKS <TERM>
	<TERM>
	<TERM>
← Signature →	SIGNATURE <TERM>
	<TERM>
	<TERM>

_____ Space, ASCII 20h
 <TERM> Terminator, CR LF or CR
 CR Carriage return, ASCII 0Dh
 LF Line feed, ASCII 0Ah

Sensitivity adjustment report using an external weight

This is the GLP report when the sensitivity of the balance is adjusted using an external weight.

When "inF0 l" is set.

Printer format (AD-8127)

PC format (RsCom)

<pre> A & D MODEL GX-10002A S/N 123456789 ID LAB-0123 DATE 2017/12/31 TIME 12:34:56 CALIBRATED(EXT.) CAL.WEIGHT +10000.00 g REMARKS SIGNATURE ----- </pre>	<p>← Manufacturer →</p> <p>← Model →</p> <p>← Serial number →</p> <p>← ID number →</p> <p>← Date →</p> <p>← Time →</p> <p>← Sensitivity adjustment type →</p> <p>← Sensitivity adjustment weight →</p> <p>← Remarks →</p> <p>← Signature →</p>	<pre> _____ A_&_D <TERM> MODEL__GX-10002A <TERM> S/N___123456789 <TERM> ID____LAB-0123 <TERM> DATE__2017/12/31 <TERM> TIME___12:34:56 <TERM> CALIBRATED(EXT.) <TERM> CAL.WEIGHT <TERM> _____ +10000.00 __g <TERM> REMARKS <TERM> <TERM> <TERM> SIGNATURE <TERM> <TERM> <TERM> -----<TERM> <TERM> <TERM> </pre>
-----------------------------------------------------------------------------------------------------------------------------------------------------------------------------------	------------------------------------------------------------------------------------------------------------------------------------------------------------------------------------------------------------------------------------------------	--------------------------------------------------------------------------------------------------------------------------------------------------------------------------------------------------------------------------------------------------------------------------------------------------------------------------------------------------------------------------------------------------------------------------------

_____ Space, ASCII 20h
 <TERM> Terminator, CR LF or CR
 CR Carriage return, ASCII 0Dh
 LF Line feed, ASCII 0Ah

Calibration test report using an external weight

This is the GLP report when checking the weighing accuracy of the balance with an external weight.

(Adjustment is not performed)

When "inF0 l" is set:

Printer format (AD-8127)

PC format (RsCom)

<pre> A & D MODEL GX-10002A S/N 123456789 ID LAB-0123 DATE 2017/12/31 TIME 12:34:56 CAL.TEST(EXT.) ACTUAL 0.00 g +9999.95 g TARGET +10000.00 g REMARKS SIGNATURE ----- </pre>	<p>← Manufacturer →</p> <p>← Model →</p> <p>← Serial number →</p> <p>← ID number →</p> <p>← Date →</p> <p>← Time →</p> <p>← Calibration test →</p> <p>← Zero point value →</p> <p>← Target weight value →</p> <p>← Target weight →</p> <p>← Remarks →</p> <p>← Signature →</p>	<pre> _____ A_&_D <TERM> MODEL__GX-10002A <TERM> S/N___123456789 <TERM> ID____LAB-0123 <TERM> DATE__2017/12/31 <TERM> TIME___12:34:56 <TERM> CAL.TEST(EXT.) <TERM> ACTUAL <TERM> _____ 0.00 __g <TERM> _____ +9999.95 __g <TERM> TARGET <TERM> _____ +10000.00 __g <TERM> REMARKS <TERM> <TERM> <TERM> SIGNATURE <TERM> <TERM> <TERM> </pre>
------------------------------------------------------------------------------------------------------------------------------------------------------------------------------------------------------------------	--------------------------------------------------------------------------------------------------------------------------------------------------------------------------------------------------------------------------------------------------------------------------------	--------------------------------------------------------------------------------------------------------------------------------------------------------------------------------------------------------------------------------------------------------------------------------------------------------------------------------------------------------------------------------------------------------------------------------------------------------------

_____ Space, ASCII 20h
 <TERM> Terminator, CR LF or CR
 CR Carriage return, ASCII 0Dh
 LF Line feed, ASCII 0Ah

Title block and End block

Application / Operation

"Title block" and "End block" can be added before and after a series of weighing values for data management.

Pressing and holding the **PRINT** key for 2 seconds outputs "Title block" and "End block" alternately.

Note

If the data memory function is used, Title block and End block cannot be output.

Output method using the keys

1. With the weighing value displayed, press and hold the **PRINT** key for 2 seconds until **START** is displayed to output "Title block".
2. Output the weighing value. The output method depends on the setting of the data output mode.
3. Press and hold the **PRINT** key for 2 seconds until **Rec End** is displayed to output "End block".

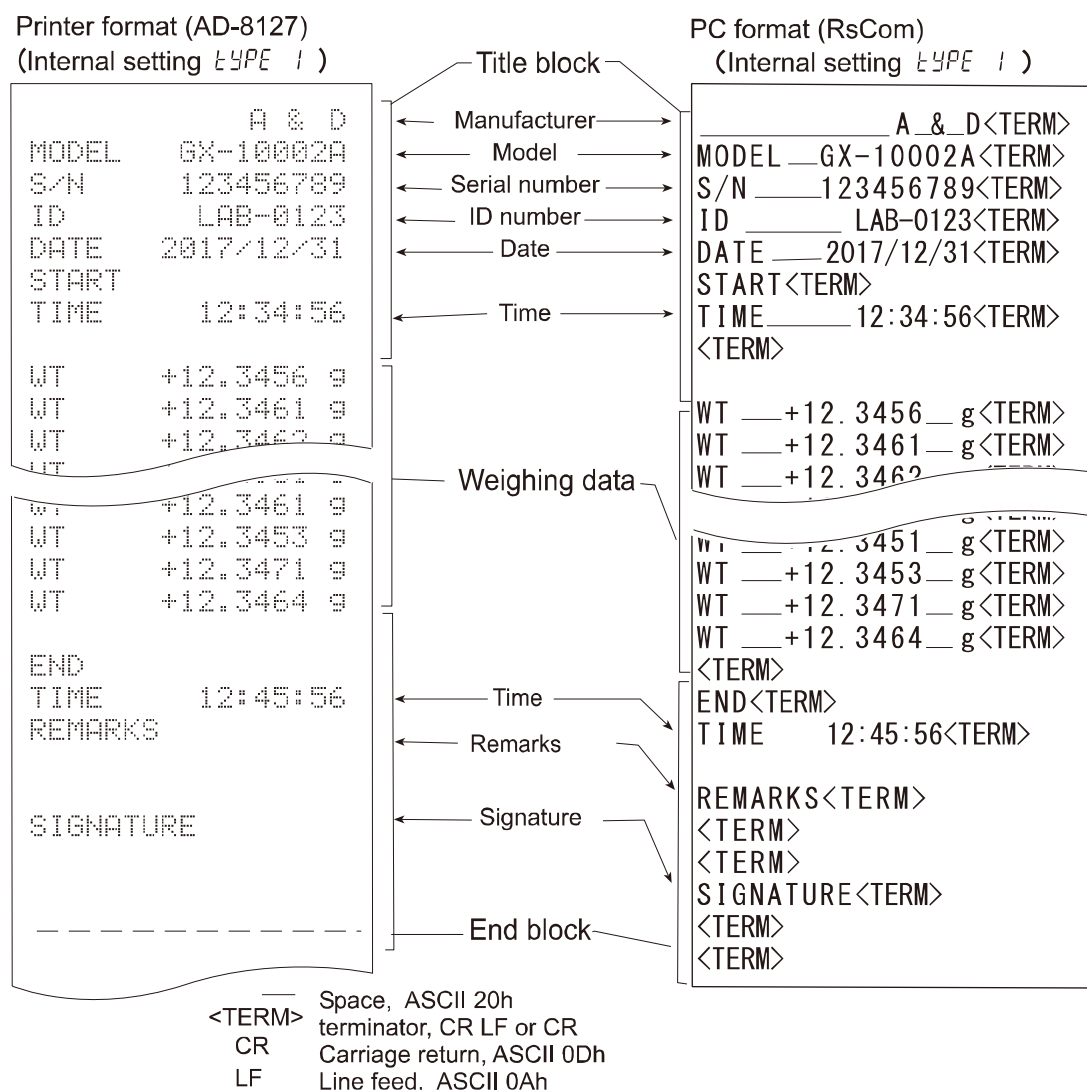

11. Data Memory

Data memory is a function to store in the balance unit masses for counting mode, weighing results, sensitivity adjustment results, etc., and afterward to perform data confirmation or batch output.

The following six types of data can be stored.

1. Unit mass (Counting mode)	Up to 50 sets
2. Weighing value	Up to 200 sets
Sensitivity adjustment report 3. Internal mass sensitivity adjustment 4. External weight sensitivity adjustment Calibration test report 5. Internal mass calibration test (0.0001g models only) 6. External weight calibration test	Latest 50 sets

11-1. Data Memory For Weighing Data

Features

- Weighing results can be stored in the internal memory of the balance.
- The balance can store weighing results so that you can continue weighing work without a printer or a personal computer connected.
- The balance can store weighing results so that you can perform weighing work without occupying a printer or PC for a long time.
- Stored data can be displayed on the balance for data confirmation.
- Stored data can be output in batch (to a PC or optional printer). The output format and whether to add a data number, time/date, and ID number can be selected with the function table.
- The balance has a capacity to store up to 200 weighing results with timestamp.
* For how to store unit masses, refer to "4-3 Counting Mode (PCS)".

Storing the weighing results and sensitivity adjustment results

1. Set the "Data memory (dAtA)" of the function table to "Stores weighing data and sensitivity adjustment history (dAtA 2)". Refer to "9. Function Table" and the following "Enabling data memory function".
2. With "Time/Date output (5-td)" of the function table, set whether to add timestamp.
3. How to store the weighing results depends on the operation of "Data output mode (PrL)" of the function table.

Note

When PrL 3 (stream mode) is set, data may not be stored correctly.

* The time and date settings can be changed after the weighing values are stored.

Enabling data memory function

1. Press and hold the **SAMPLE** key for 2 seconds until **bASFnC** is displayed.
2. Press the **SAMPLE** key several times to display **dout**.
3. Press the **PRINT** key.
4. Press the **SAMPLE** key several times to display **dAtA**.
5. Press the **RE-ZERO** key to display **dAtA We/LRL**.
6. Press the **PRINT** key to store the setting.
7. Press the **CAL** key to return to the weighing mode.

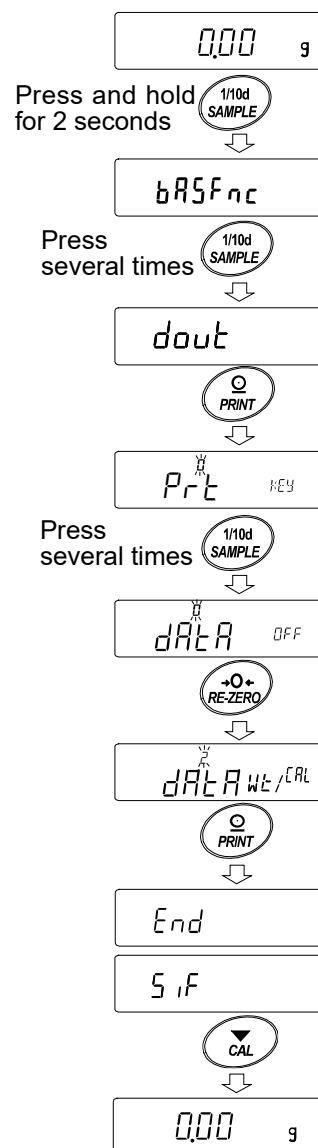

Display and symbol

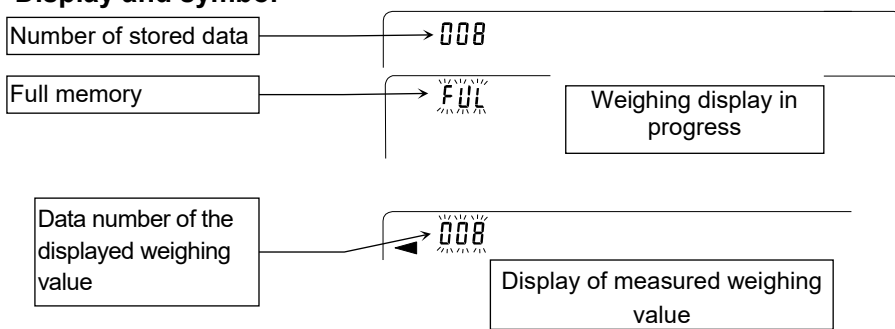

When the volume of measured values stored reaches its maximum, **FUL** ↔ **dAt** blink in turn.

Caution

- When weighing data is being stored in memory, the data is output simultaneously using RS-232C or USB interface.
- "FUL" indicates that memory is full or the memory capacity has been reached. More data cannot be stored unless the stored data is deleted.
- When the interval output mode is operating, automatic sensitivity adjustment due to temperature change is not performed.
- The statistical calculation function cannot be used while the data memory function is being used.

Setting the function table

Parameter settings for each output mode are as follows:

Mode \ Item	Data output mode	Auto print polarity, difference	Data memory function	Interval time
Key mode	<i>Pr</i> t 0	Not used	<i>dAtA</i> 2	Not used
Auto print mode A	<i>Pr</i> t 1	<i>AP-A</i> 0 to 2	<i>dAtA</i> 2	
Auto print mode B	<i>Pr</i> t 2	<i>AP-b</i> 0 to 2	<i>dAtA</i> 2	
Key mode B (immediate)	<i>Pr</i> t 4	Not used	<i>dAtA</i> 2	
Key mode C (stable)	<i>Pr</i> t 5		<i>dAtA</i> 2	
Interval output mode	<i>Pr</i> t 6		<i>dAtA</i> 2	

Parameter settings for Data number, ID number, Time/Date

Data number	No	<i>d-no</i> "0"	Time/Date	No	<i>S-t</i> d 0	—
	Yes	<i>d-no</i> "1"		Time only	<i>S-t</i> d 1	Up to 200 sets
ID number	No	<i>S-id</i> "0"		Date only	<i>S-t</i> d 2	
	Yes	<i>S-id</i> "1"		Both	<i>S-t</i> d 3	

Displaying the stored weighing results

Note

Confirm that the "Data memory (*dAtA*)" parameter is set to "Stores the weighing data and sensitivity adjustment history (*dAtA* 2)".

- Press and hold the **PRINT** key for 2 seconds until **RECALL** is displayed.

"-d- or d-t" [types of weighing results] appears in the upper left of the display.

Left of the display

-d-

When setting without clock / date
or

d-t

When setting with clock / date

- Press the **PRINT** key to enter the memory recall mode. Operate the following keys.

RE-ZERO key.....Displays the next data set.

MODE key.....Displays the previous data set.

PRINT key.....Outputs the displayed data via RS-232C or USB.

CAL key.....Exits the memory recall mode.

- Press the **CAL** key to return to the weighing mode.

* The time and date output settings can be changed after the weighing values are stored.

Outputting stored weighing results in batch

Note

In order to output in batch, "Serial interface (S,F)" of the function table must be configured. Refer to "9. Function Table" and "Communication manual" on A&D website (<https://www.aandd.jp>).

1. Press and hold the **PRINT** key for 2 seconds until **RECALL** is displayed.
2. Press the **SAMPLE** key to display **out**.
3. Press the **PRINT** key to display **out No** with "No" blinking.
4. Press the **RE-ZERO** key to display **out Go** with "Go" blinking.
5. Press the **PRINT** key to output the stored data all at once via RS-232C/USB.
6. The balance displays **CLEAR** when the output is completed.
Press the **CAL** key to return to the weighing mode.

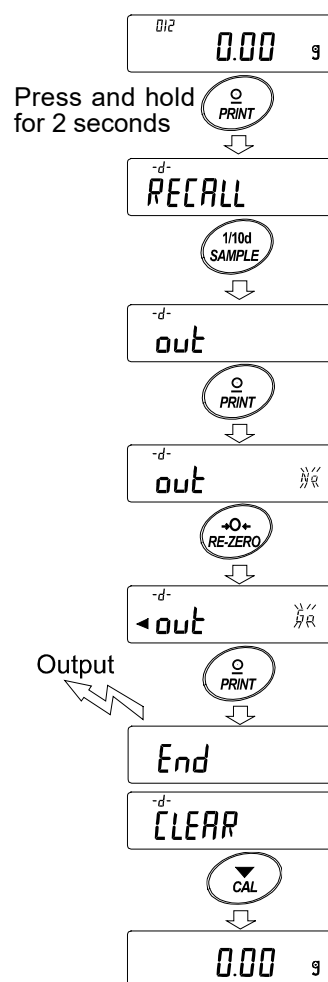

Deleting the stored weighing results in batch

1. Press and hold the **PRINT** key for 2 seconds until **RECALL** is displayed.
2. Press the **SAMPLE** key several times to display **CLEAR**.
3. Press the **PRINT** key to display **CLEAR No** with "No" blinking.
4. Press the **RE-ZERO** key to display **CLEAR Go** with "Go" blinking.
5. Press the **PRINT** key to delete all the stored data.
6. The balance displays **End** when the deletion is completed, then returns to the weighing mode.

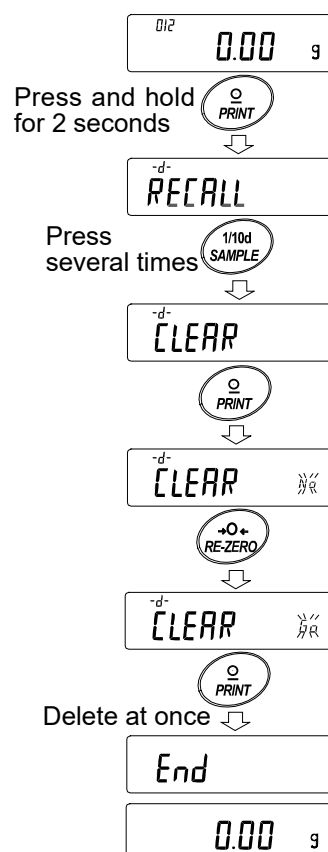

11-2. Data Memory For Sensitivity Adjustment And Calibration Test

Features

- The results of sensitivity adjustment (with the internal mass/an external weight) results and calibration test results can be stored in the internal memory of the balance.
- The stored results can be output (to an optional printer or personal computer) in batch.
- The balance has a capacity to store up to 50 sensitivity adjustment /calibration test results.

* When the memory capacity of up to 50 sets has been reached,

"FUL" ↔ "CAL" indicators blink in turn.

Upper left of the display

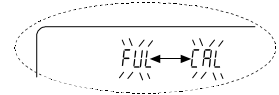

Storing the sensitivity adjustment and calibration test results

1. Set the "Data memory (dAtA)" parameter to "Stores weighing data and sensitivity adjustment history (dAtA 2)". Refer to "9 Function Table".
2. With the settings above, each time sensitivity adjustment or calibration test is performed, the data is stored automatically.

Outputting sensitivity adjustment history

1. In the weighing mode, press and hold the **CAL** key for 2 seconds. When **CAL H,5** is displayed, release your finger from the key. **out** appears.

If there is no sensitivity adjustment history, **No dAtA** is displayed, then the display returns to the weighing mode.

2. Press the **PRINT** key to display **out** **NR**.

3. Switch **No / GO** with the **RE-ZERO** key to display **out** **GO**.

4. With **out** **GO** displayed, press the **PRINT** key to start output in batch.

The output format is compliant with "GLP output".

5. When output is completed, **End** is displayed, and then **CLEAR** appears.

6. To delete saved histories all at once, go to following "Deleting sensitivity adjustment history".

To return to the weighing values, press the **CAL** key.

* If the **FUL** ↔ **CAL** indicators are blinking in turn with weighing display, 50 sets of data have been already stored in memory.

If a new result is saved in this state, the oldest data will be overwritten. Delete some of the saved data.

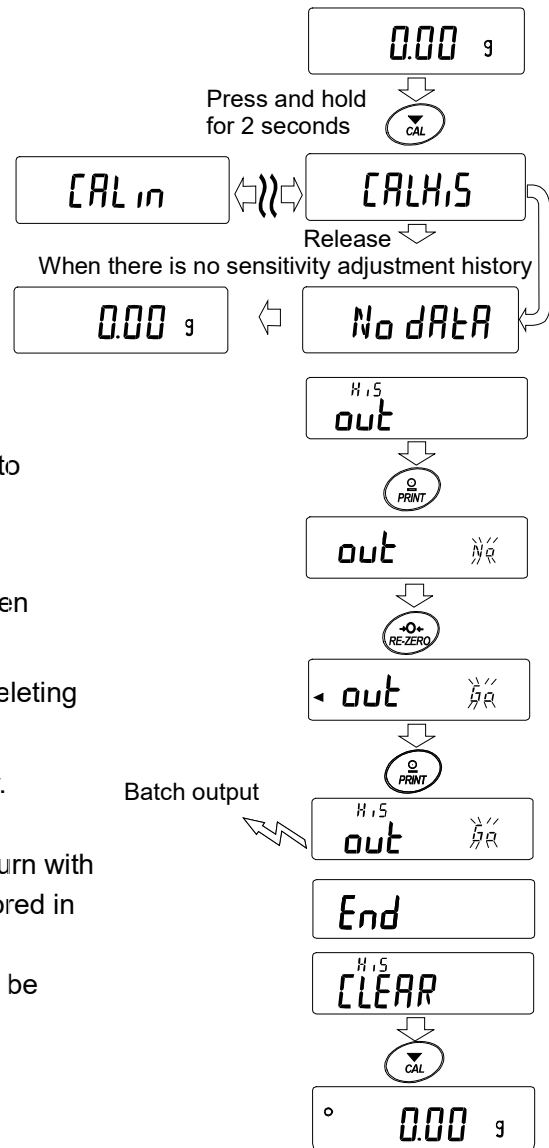

Deleting sensitivity adjustment history

1. Press and hold the **CAL** key for 2 seconds.
When **CAL H,5** is displayed, release the key.
out appears.
2. Press the **SAMPLE** key to display **CLEAR**.
3. Press the **PRINT** key to display **CLEAR No**.
4. Press the **RE-ZERO** key to toggle between **No** / **Go** to display **CLEAR Go**.
5. With **CLEAR Go** displayed, press the **PRINT** key to start deleting all at once.
6. When deletion is completed, the balance displays **End** and returns to the weighing mode.

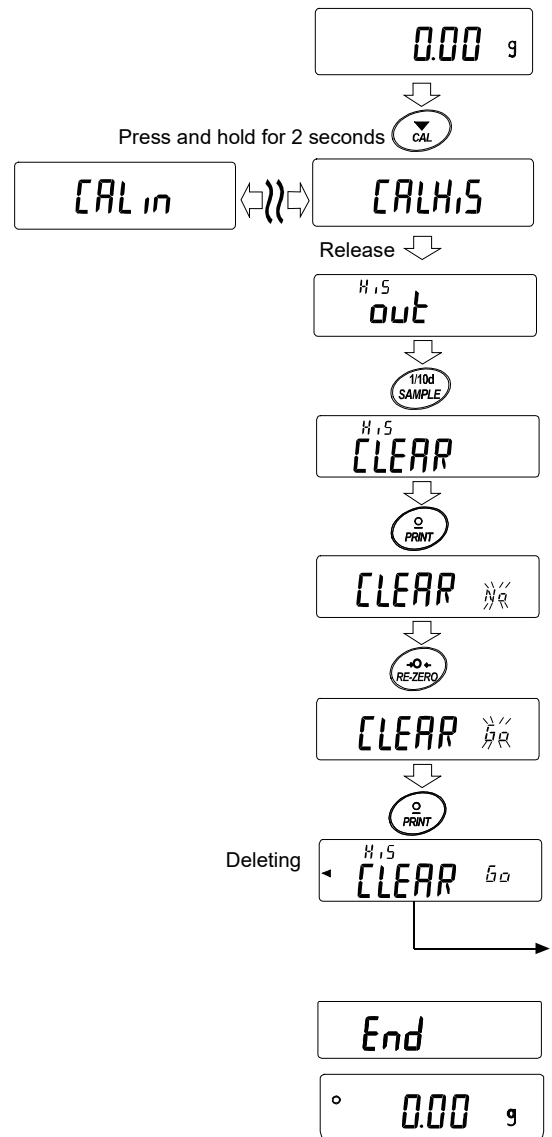

12. Statistical Calculation Mode

The statistical calculation mode statistically calculates the weight data, and displays or outputs the results. To use the statistical calculation mode, set the "Application function (APF)" parameter of "Application (AP Fnc)" in the function table to "2", as described below. To return to the normal weighing mode (factory setting), set "Application mode (APF)" to "0".

Statistical items available are number of data, sum, maximum, minimum, range (maximum-minimum), average, standard deviation, coefficient of variation, and relative error. What statistical items to output can be selected from the four modes in the function table (SEPF).

- The wrong data input can be canceled by the key operation, if immediately after the input.
- Turning the balance off will delete the statistical data.
- The standard deviation, coefficient of variation, and relative error are obtained by the equation below:

$$\text{Standard deviation} = \sqrt{\frac{N \cdot \sum (X_i)^2 - (\sum X_i)^2}{N \cdot (N-1)}} \quad \text{where } X_i \text{ is the } i\text{-th weight data,}$$

N is number of data.

$$\text{Coefficient of variation (CV)} = \frac{\text{Standard deviation}}{\text{Average}} \times 100 (\%)$$

$$\text{Relative error of maximum value} = \frac{\text{Maximum value} - \text{Average}}{\text{Average}} \times 100 (\%)$$

$$\text{Relative error of minimum value} = \frac{\text{Minimum value} - \text{Average}}{\text{Average}} \times 100 (\%)$$

Note

- When there is data with a readability digit off, the calculation result is displayed with the readability digit off. (Readability digit is rounded off.)
- When the data memory function is in use, the statistical calculation function cannot be used.
- When registering the warning function of the minimum weighing value, the statistical calculation function cannot be used.

12-1. How To Use The Statistical Calculation

Switching to the statistical function mode (Changing the function table)

1. Press and hold the **[SAMPLE]** key for 2 seconds until **bASFnC** is displayed.
2. Press the **[SAMPLE]** key several times to display **AP Fnc**.
3. Press the **[PRINT]** key to display **APF N=0**.
4. Press the **[RE-ZERO]** key several times to display **APF S=7c**.

To select statistical items to output, go to step 5.

To store the statistical function mode settings, go to 7.

To disable the statistical calculation mode, press the

[RE-ZERO] key to select **APF N=0**.

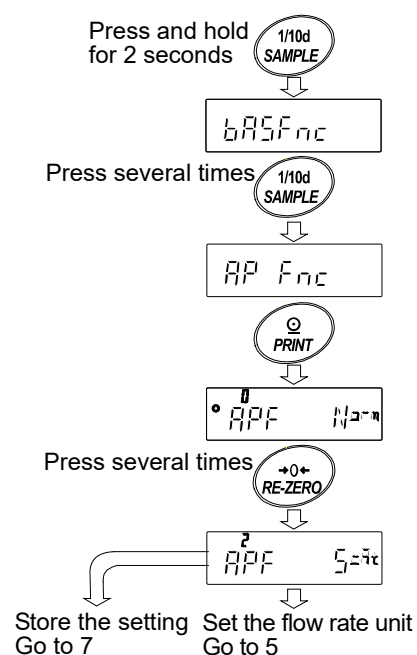

Selecting the statistical items to output

- Press the **SAMPLE** key to display $\cdot \overline{0} \text{STAT}$.
- Press the **RE-ZERO** key to select the output items.
In the example, the number of data, sum, maximum, minimum, range (maximum - minimum) and average are selected as the output items.

Parameter	Description
$\cdot \overline{0}$	Number of data, sum
$ $	Number of data, sum, maximum, minimum, range (maximum – minimum), average
$\{$	Number of data, sum, maximum, minimum, range (maximum – minimum), average, standard deviation, coefficient of variation
$\}$	Number of data, sum, maximum, minimum, range (maximum – minimum), average, standard deviation, coefficient of variation, relative error of maximum value, relative error of minimum value

- Press the **PRINT** key to store the setting.
- Press the **CAL** key to return to the weighing mode.

Selecting the unit

- Press the **MODE** key to select the unit to be used for the statistical calculation mode. (In the example shown on the right, gram is selected.)

Continue from Step 4

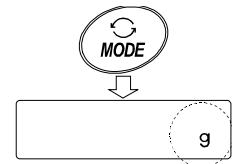
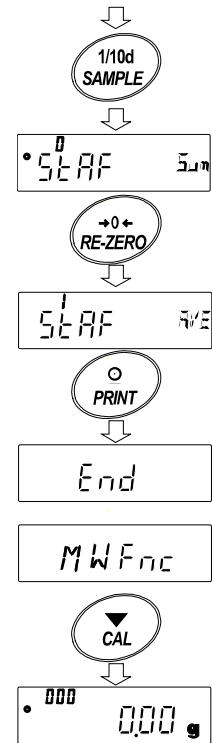

Note

Selecting the unit using the **MODE** key is not available after the data is entered. In this case, clear the data as described in "Clearing the statistical data" on page 104 and select the unit using the **MODE** key.

It is convenient to set the unit to be used in advance with "Unit (Unit)" of the function table if you want to enable the statistical unit function from the time the power is turned on.

Entering data for statistical calculation

Use the following keys to operate the statistical calculation mode.

MODE key (When the data is entered) Moves between the displaying items (weighing mode, statistical results and data operation) each time the key is pressed.
(When no data has been entered) Selects the unit.

SAMPLE key Turns the readability digit ON or OFF in weighing mode.

RE-ZERO key Sets the display to zero in weighing mode.

PRINT key Outputs the data number and the weight data and includes the weight data to statistical calculation in the weighing mode. (Output is not in the same data format as specified in “type” of the function table because of the data number added.)

Outputs the statistical results while the statistical results are displayed. (Output is not in the same data format as specified in “type” of the function table.)

CAL key Returns to weighing mode.

1. Press the **RE-ZERO** key to set the display to zero.
2. Place the sample on the weighing pan and wait for the stabilization indicator to turn on.
3. Press the **PRINT** key to add the data displayed to statistical calculation. The number of data on the upper left of the display increases by 1.
4. Repeat steps 1 to 3 for each weighing.

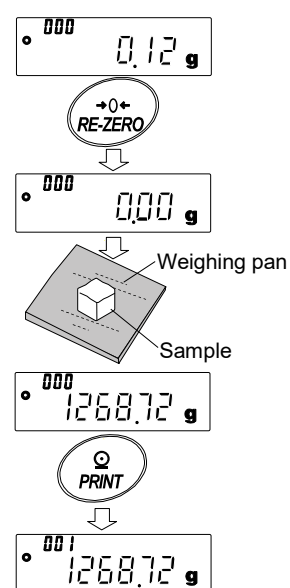

Displaying and outputting the statistical results

- Each time the **MODE** key is pressed, the display shows the statistical result set in "Statistical function mode output items (StatF)" followed by **CLEAR** and **CANCEL**.
Pressing the **SAMPLE** key displays the previous item.

Note

- When the number of data is one, the coefficient of variation and relative error are displayed as **-----**.
 - When the average is 0, the coefficient of variation and relative error are displayed as **-----**.
 - Statistical items are indicated on the upper left of the display using the following symbols.
- When the statistical result is displayed, pressing the **PRINT** key outputs the statistical result.

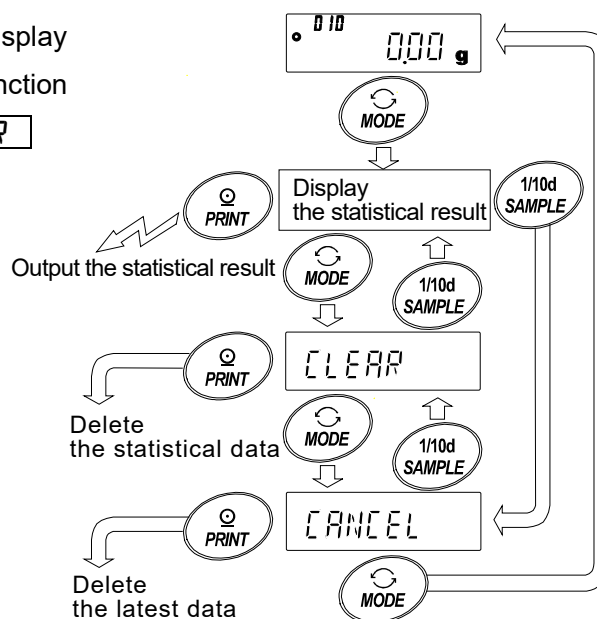

Symbol	Statistical item
$\Sigma u \bar{n}$	Sum
$\bar{n} \bar{M} \bar{H}$	Maximum
$\bar{n} \bar{I} \bar{n}$	Minimum
r	Range (maximum – minimum)
$\bar{A} \bar{V} \bar{E}$	Average
$S \bar{d}$	Standard deviation
$C \bar{V}$	Coefficient of variation
$\bar{n} \bar{M} \bar{H} \%$	Relative error of maximum value
$\bar{n} \bar{I} \bar{n} \%$	Relative error of minimum value

Output example

N	10
SUM	+ 1000.00g
MAX	+ 105.00g
MIN	+ 95.00g
R	+ 10.00g
AVE	+ 100.00g
SD	+ 2.800g
CV	+ 2.8 %
MAX%	+ 5.0 %
MIN%	+ 5.0 %

Function table parameter (StatF)

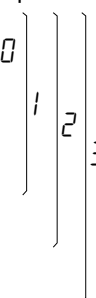

Deleting the latest data

When the wrong data is entered, it can be deleted and excluded from statistical calculation. Only the latest data can be deleted.

- In the weighing mode, press the **MODE** key to display **CANCEL**.
- Press the **PRINT** key to display **CANCEL No**.
- Press the **RE-ZERO** key to display **CANCEL 50**.
- Press the **PRINT** key to delete the latest data and exclude it from statistical calculation. The number of data decreases by one when the balance returns to the weighing mode.

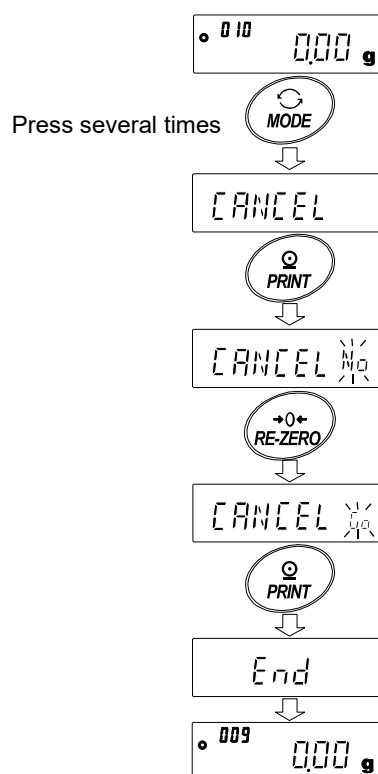

Clearing the statistical data

All the statistical data will be deleted and the number of data will be zero.

1. In the weighing mode, press the **MODE** key.
2. The statistical data is displayed. Press the **MODE** key several times to display **CLEAR**.
3. Press the **PRINT** key to display **CLEAR No**.
4. Press the **RE-ZERO** key to display **CLEAR Go**.
5. Press the **PRINT** key to initialize the statistical data. The data count becomes 0 (zero) when the balance returns to the weighing mode.

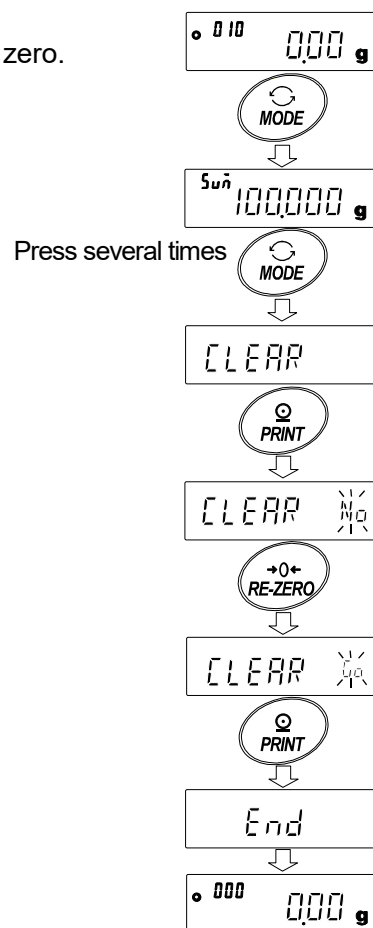

12-2. Statistical Calculation Mode (Example Of Use)

Here, as an example of use of the statistical calculation mode, mixing of formula ingredients such as chemicals is described. The mixing process is recorded using the balance and the printer.

In the example, the GX-303A and the AD-8127 are connected using the RS-232C serial interface.

Changing the function table

- Changes
- To enable the statistical calculation mode
 - To enable “Zero after output”

Enabling the statistical calculation mode

1. Enter the function table menu.

Press and hold the **SAMPLE** key for 2 seconds until **bAS5Fnc** of the function table is displayed, then release the key.

2. Select the application function.

Press the **SAMPLE** key several times to display **AP Fnc**. Then, press the **PRINT** key to display **APF Norm**.

3. Change the application function parameter to “2”.

Press the **RE-ZERO** key to display **APF 2 Stat**.

Press the **PRINT** key to confirm the change.

After **End** is displayed, **MW Fnc** appears.

Enabling “Zero after output”

4. Select “Zero after output”.

Press the **SAMPLE** key several times to display **dout**.

Press the **PRINT** key to display **PrE KEF**, and then

press the **SAMPLE** key several times to display **Pr-d OFF**.

5. Enable “Zero after output”.

Press the **RE-ZERO** key to display **Pr-d ON**. Then, press the **PRINT** key to confirm the change.

After **End** is displayed, **SIF** appears.

Returning to the weighing mode

6. Press the **CAL** key to return to weighing mode.

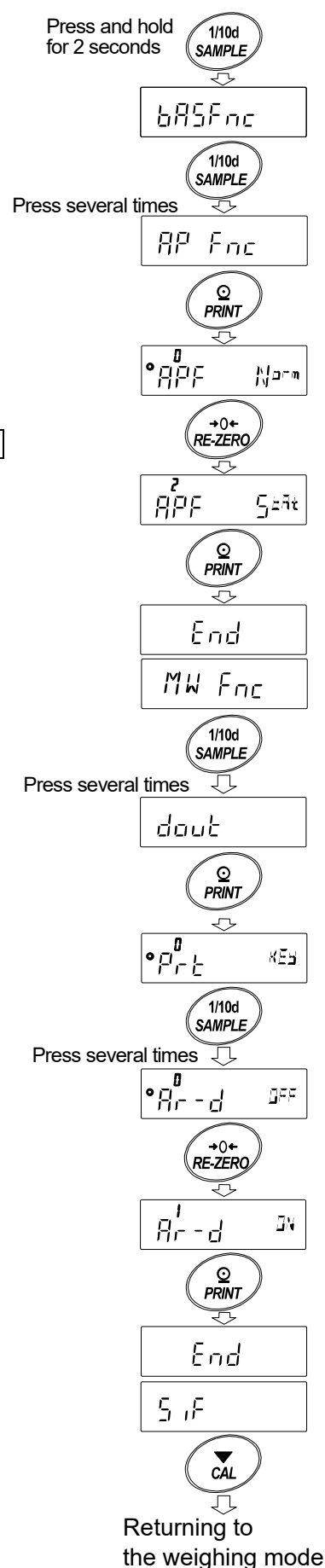

How to use the statistical calculation mode

1. Press the **RE-ZERO** key to set the display to zero.
2. Place a container on the weighing pan.
Press the **PRINT** key to cancel the weight (tare). The balance displays **0.000 g**. (Storing the tare value)
The tare value data is output when the peripheral output equipment is connected.
3. Weigh formula ingredient 1 and press the **PRINT** key. The balance displays **0.000 g**. (Storing the weight value of formula ingredient 1)
The weight value data is output when the peripheral output equipment is connected.
4. Weigh formula ingredient 2 and press the **PRINT** key. The balance displays **0.000 g**. (Storing the weight value of formula ingredient 2)
The weight value data is output when the peripheral output equipment is connected.
5. When there are more formula ingredients to be added, repeat step 4.
6. After mixing is completed, press the **MODE** key to display the statistical results.
7. Press the **PRINT** key to output the number of data saved including the tare value and the total weight.

Output example

No. 1	ST,+0005.637 g Tare value
No. 2	ST,+0001.992 g Formula ingredient 1
No. 3	ST,+0007.780 g Formula ingredient 2
N	3	
SUM	+15.409 g Total weight

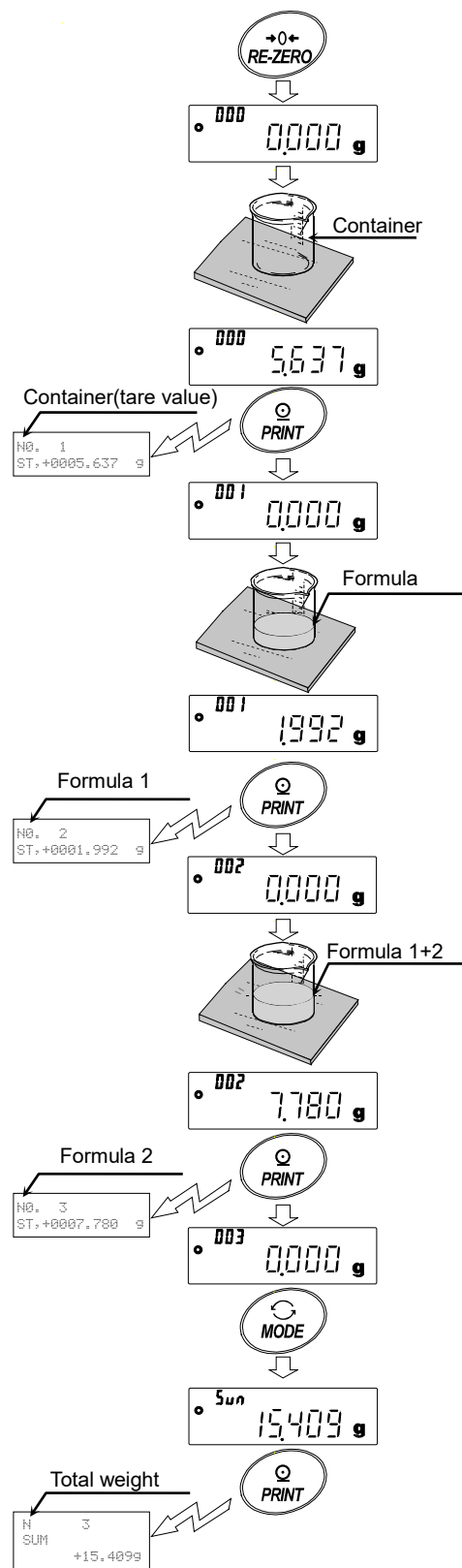

13. Flow Measurement

The balance has "flow rate mode" for calculating the amount of change in weighing values over time. For details, please download "FRD Addendum" from the A&D website (<https://www.aandd.jp>) and refer to it.

- Densities can be registered when the unit of flow rate is set to mL/*. Up to 10 densities can be stored. If densities are set in advance, it is possible to select one according to the sample.
- The flow rate value is calculated by the following formula.

$$Q = \frac{W - W'}{Ct}$$

Q : Flow rate

Ct : Flow rate calculation time

W : Current weighing value

W' : Weighing value before Ct

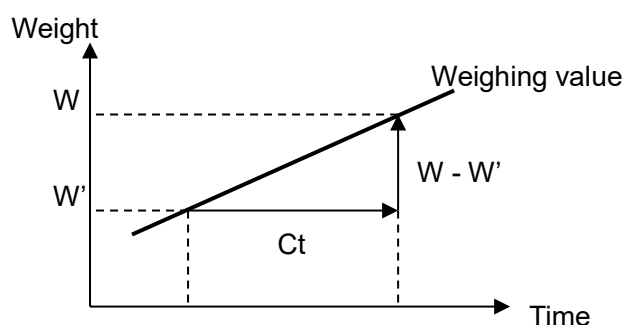

For flow rate calculation time Ct, either manual or automatic setting can be selected.

13-1. How To Use Flow Measurement

Enabling flow rate measurement

Switching flow rate measurement mode (Change in the function table)

1. Press and hold the **SAMPLE** key for 2 seconds until **bASFnC** of the function table is displayed.
2. Press the **SAMPLE** key several times to display **APFnC**.
3. Press the **PRINT** key to display **APF Norm**.
4. Press the **RE-ZERO** key several times to display **APF Frd**.

To change the unit of flow rate, go to step 5.

To store the settings, go to step 7.

To cancel the flow rate function, press the **RE-ZERO** key several times to return to **APF Norm**.

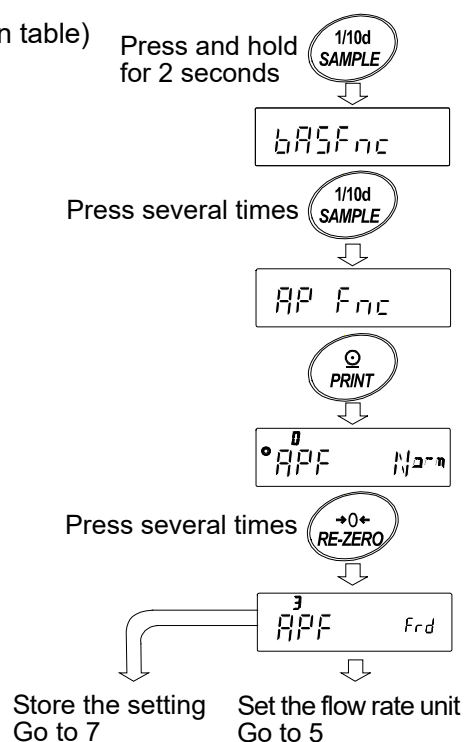

Setting the unit of flow rate

- Press the **SAMPLE** key to display $^{\circ} Frd Unit$.
- Press the **RE-ZERO** key to select the parameter.

Parameter	Description
0	g/s (gram/second)
1	g/m (gram/minute)
2	g/h (gram/hour)
3	mL/s (milliliter/second)
4	mL/m (milliliter/minute)
5	mL/h (milliliter/hour)

▪ Factory setting

- Press the **PRINT** key to store the setting.
- Press the **CAL** key to return to the calculation display.

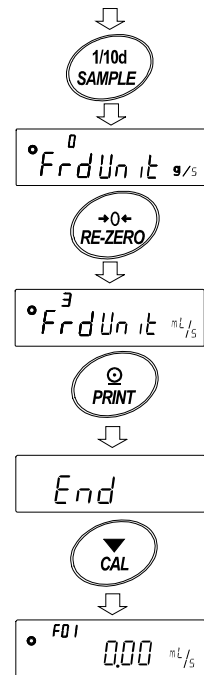

Selecting manual/automatic setting of flow rate calculation time Ct

There are two ways to set the flow rate calculation time Ct: automatic setting according to flow rate and manual setting of fixed value.

To switch between manual setting/automatic setting, perform the following operations. By default, flow calculation time Ct is set to manual input setting ($Ct Auto "OFF"$).

- With $^{\circ} Frd Unit mL/s$ displayed (for flow rate unit setting in "13-1 How To Use Flow Measurement"), perform the following operations.
- Press the **SAMPLE** key to display $^{\circ} Ct Auto$.
- Press the **RE-ZERO** key to switch ON/OFF.
- Press the **PRINT** key to store the setting.
- Press the **CAL** key to return to the calculation display.

When "OFF" is set, refer to "Manual setting" to set the flow rate calculation time.

When "ON" is set, refer to "Automatic setting" to set the flow rate calculation accuracy.

From setting of flow rate unit

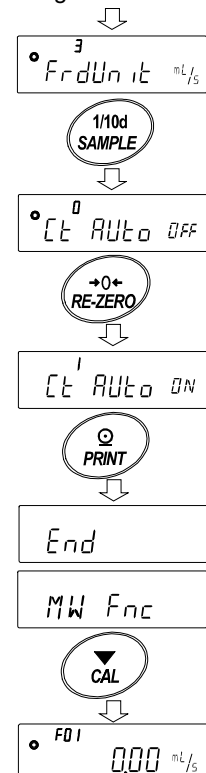

Manual setting

The flow rate calculation time Ct can be set by the following procedure.

1. In weighing mode, press and hold the **MODE** key for 2 seconds to display **Et 2 SEC**.
2. Change the flow rate calculation time with the following keys.
Set a value between 1 second and 1 hour.

RE-ZERO (+) key ··· Changes the flow rate calculation time.

MODE (-) key ····· Changes the flow rate calculation time.

PRINT key ······· Stores the new value.

When the flow rate unit is g / *, returns to weighing or flow rate display.

When the flow rate unit is mL / *, goes to density setting display.

CAL key ······· Returns to weighing or flow rate display without storing the setting value.

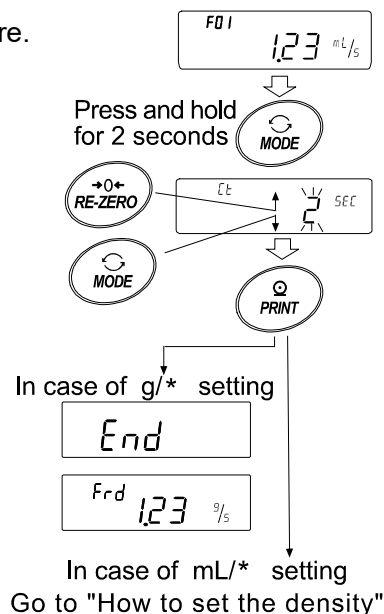

Note In place of "*" of "g / *" and "mL / *", the set time unit (second [s], minute [m], or hour [h]) is displayed. For setting guideline, refer to "GX-A/GF-A Series Flow Measurement Function Supplementary Manual".

Automatic setting

Flow rate measurement can be performed without the trouble of selecting the flow rate calculation time Ct matching the flow rate from the setting values.

The flow rate calculation time Ct can be determined between 1 and 60 seconds according to the flow rate being measured. The flow rate calculation accuracy can be selected from "Priority to precision (Resolution 500)", "Standard Setting (Resolution 200)" and "Priority to response (Resolution 50)".

The flow rate calculation accuracy can be changed by the following procedure.

1. In weighing mode, press and hold the **MODE** key for 2 seconds to display **Fr RES**.
2. Press the **RE-ZERO** key to set the desired parameter.

Parameter	Description
0	Priority to precision (Resolution 500)
1	Standard setting (Resolution 200)
2	Priority to response (Resolution 50)

■ Factory setting

3. Press the **PRINT** key to store the setting.
When the flow rate unit is g/*, the weighing or flow display appears.
When the flow rate unit is mL/*, the density setting follows.
Please refer to "Density setting".

Note In place of "*" of "g / *" and "mL / *", the set time unit (second [s], minute [m], or hour [h]) is displayed.

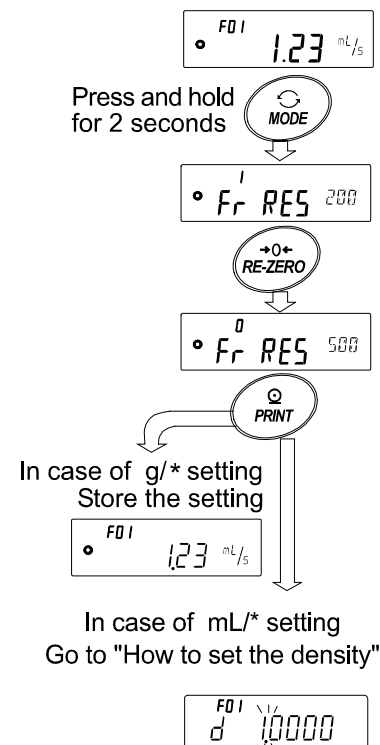

Density setting

When **Frd Unit** in the function table is set to 3, 4, or 5, the density setting follows after the setting of flow rate calculation time or flow rate calculation accuracy.

Density can be changed with the following key operations.

Set a value between 0.0001g/cm³ and 9.9999g/cm³.

RE-ZERO (+) key ... Changes the value of the selected (blinking) digit.

MODE (-) key ... Changes the value of the selected (blinking) digit.

SAMPLE key ... Selects the digit to blink.

PRINT key ... Stores the set value and returns to weighing or flow rate display.

CAL key ... Returns to weighing or flow rate display without storing the set value.

Continued from flow calculation time or flow calculation accuracy setting

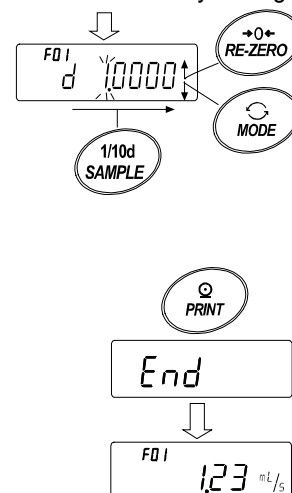

Reading out a density number

When the flow unit is mL/*, up to 10 densities can be registered.

To register a new density, select an unused density number and then register a value according to the flow rate calculation time or flow rate calculation accuracy setting procedure.

In weighing mode, press and hold the **PRINT** key for 2 seconds to display **d*.******.

F** displays the current density number while blinking and

d*.**** displays the set density value.

The density number can be changed with the following keys.

Set a value between F01 and F10.

Note

F** : The selected density number is displayed.

d*.**** : The set density number is displayed.

RE-ZERO (+) key ... Changes the density number.

MODE (-) key ... Changes the density number.

PRINT key ... Reads the density of the selected density number and returns to weighing or flow rate display.

CAL key ... Returns to weighing or flow rate display without reading the density of the selected density number.

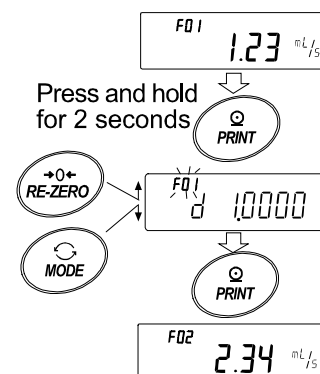

Switching the display

When the display returns to the weighing value display after the flow rate mode setting, the unit "g" is displayed with **Frd** or **F**** lighted.

Use the **MODE** key to switch between flow rate display and "g" display. By switching, the total amount and flow rate can be checked.

Note

F** : The selected density number is displayed. (F01 to F10)

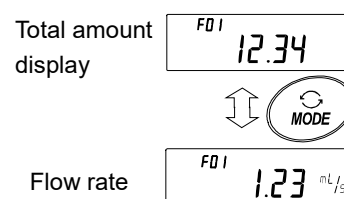

14. Gross Net Tare Function

Zero setting and tare operation can be performed separately, and gross weight, net weight, and tare weight data can be output.

When the gross net tare function is selected, the key operations are changed as follows.

Key	Operation
ON:OFF key	Zero setting (Operate as the ZERO key)
RE-ZERO key	Tare (Operate as the TARE key)

To use the gross net tare function, it is necessary to change the function table.

14-1. Preparations For Gross Net Tare Function

To use the gross net tare function, it is necessary to set "Application mode (APF)" of "Application function (AP Fnc)" to "4" in the function table. To return to the normal weighing mode (factory setting), set "Application mode APF" to "0".

Follow the procedure below to set the function.

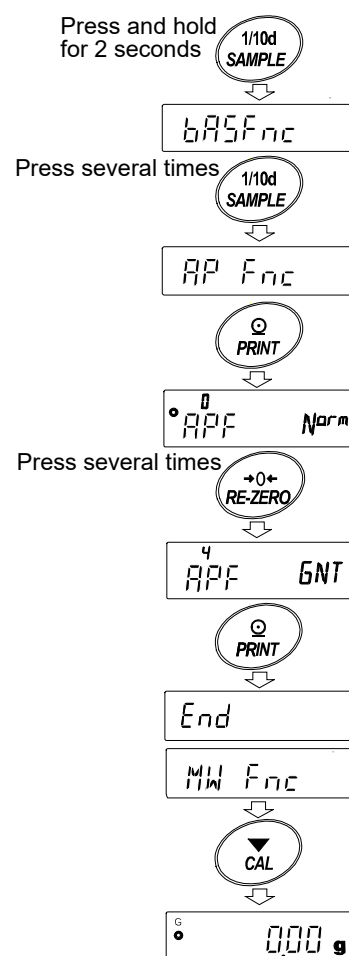

Setting procedure

1. Press and hold the **SAMPLE** key for 2 seconds until **bASFnC** of the function table is displayed.
2. Press the **SAMPLE** key several times to display **AP Fnc**.
3. Press the **PRINT** key to display **APF Norm**.
4. Press the **RE-ZERO** key several times to display **APF GNT**.
5. Press the **PRINT** key to store the setting.
6. Press the **CAL** key to return to weighing display.



Key operation

The following keys work according to the weighing value (gross weight).

Key	Function	Weighing value (gross)	Description
	Zero setting (ZERO)	Within the zero range ^{*1}	Updates the zero point and clears the tare value.
		Exceeding the zero range ^{*1}	Does not update the zero point. Does not clear the tare value.
	Tare (TARE)	Positive value	Performs tare operation and updates the tare value.
		Gross zero ^{*2} (Gross zero indicator lights)	Clears the tare value.
		Negative value	Does not perform tare operation.

^{*1} "Zero range" means the range where the load is within $\pm 2\%$ from the reference zero to the weighing capacity.

For the zero range of each model, refer to "4-2 Basic Operation".

^{*2} "Gross zero" means that the gross weight readability is in the range of zero when the unit is "g".
(The state in which the gross zero indicator is lit.)

Note To turn off the display of the balance, press and hold the ON:OFF key for about two seconds.

Display

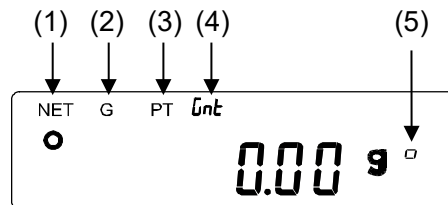

No.	Indicator	Description
(1)	NET	Lights when the tare value is other than zero.
(2)	G	Lights when the tare value is zero.
(3)	PT	Lights with the NET indicator when the preset tare is set by the PT command.
(4)	Unt	Lights when the gross net tare function is used. [*] It does not light with balance software version 1.300 or later. (When the gross net tare function is used, the NET or G indicator is always lit.)
(5)	 Gross zero	Lights when the readability of the gross is in the range of zero when the unit is "g".

Output

Pressing the **PRINT** key outputs the net weight, gross weight, and tare weight in that order.

The following output formats are supported with the balance software version.

Balance software version	Supported format
1.200 or later	A&D standard format DP format CSV format

Output example (A&D standard format)

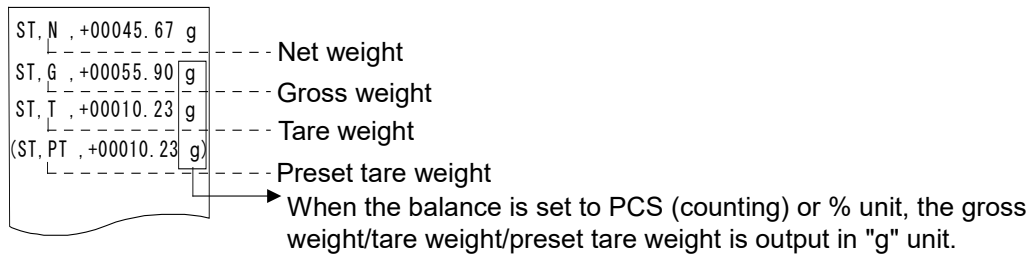

The output content and order can be set with "UFC function".

For "UFC function", please download and refer to "Communication manual" on A&D website (<https://www.aandd.jp>).

14-2. Usage Example Of The Gross Net Tare Function

1. After the gross net tare function is set, press the **ON:OFF** (ZERO) key with nothing on the weighing pan. The "G" indicator is displayed.
2. Place the tare container on the weighing pan.
3. Press the **RE-ZERO** (TARE) key to display **NET 0.00 g**. The tare value is set (updated). The "NET" indicator is displayed.
4. Place the sample on the weighing pan.
5. Press the **PRINT** key to output the net weight, gross weight, and tare weight data in that order.
6. If you remove everything on the weighing pan and press the **ON:OFF** (ZERO) key, the balance updates the zero point, clears the tare value, and returns to the state of step 1.
If you want to continue weighing without changing the tare value, remove only the sample and place the next sample on the weighing pan and then press the **PRINT** key to output the data.

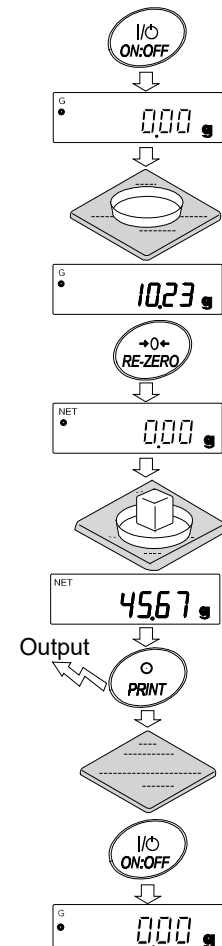

15. Minimum Weighing Warning Function

The minimum weighing value is the minimum sample weight required to perform correct quantitative analysis taking the measurement error of the balance used into account. If the sample amount is too small, the proportion of the measurement error in the measured value increases, and the reliability of the analysis result thus may drop.

With the minimum weighing warning function, it is possible to judge immediately whether the sample amount meets the set minimum weighing value.

This function can be used only with "g" mode.

With this function, "M,N" displays blinking at the top of the unit when the sample amount is less than the set minimum weighing value. When the sample amount exceeds the set minimum weighing value, "M,N" is hidden.

The minimum weighing value can be changed with the function table. The factory setting is 0 g.

Note that when the set value is 0 g, the warning is not displayed even if the minimum weighing warning function is enabled (MW-CP 1 or 2). Also, the minimum weighing value cannot be set above the weighing capacity.

There are two types of warning displays:

"Excluding near zero" MW-CP E=0

"Including near zero" MW-CP IN0

Near zero is within 0 g \pm 10 digits.

Note

- When "MW-CP" is set to a parameter other than 0, the [MODE] key is assigned to the minimum weighing value setting. Therefore, the unit cannot be changed with the [MODE] key. (The unit is fixed to the one used immediately before.)
- To change the unit, disable the minimum weighing warning function.
- To disable the minimum weighing warning function, refer to "15-1 Minimum Weighing Value Comparison" and set "MW-CP" to MW-CP OFF.

15-1. Minimum Weighing Value Comparison

1. Hold down the **[SAMPLE]** key until **bASFnC** of the function table is displayed.
2. Press the **[SAMPLE]** key several times to display **MWFnC**.
3. Press the **[PRINT]** key.
4. With **MW-CP** displayed, press the **[RE-ZERO]** key to display either **MW¹-CP E=0** (excluding near zero) or **MW²-CP IN0** (including near zero) after **MW⁰-CP OFF**.
5. To change the minimum weighing value setting, go to step 6. To return to weighing mode without changing the minimum weighing value, press the **[CAL]** key.
6. Press the **[SAMPLE]** key to display **MW**.
Perform the following procedure according to the balance software version in order to set the minimum weighing value.

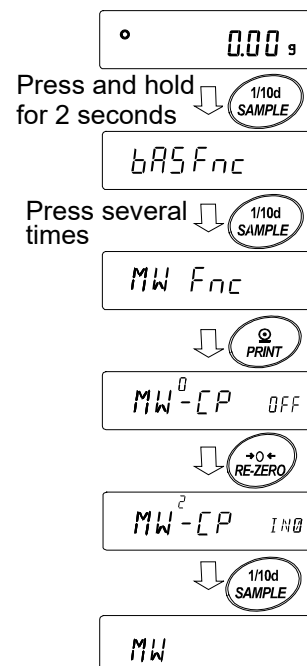

15-2. Input And Output Of The Minimum Weighing Value

15-2-1 Procedure To Set In The Function Table (With Balance Software Version 1.200 To 1.220)

Direct input of the set value

Continued from step 6 of "15-1 Minimum Weighing Value Comparison".

7. With **MW** displayed, press the **[PRINT]** key.
8. Set the minimum weighing value. The minimum weighing value can be set with the following keys.
 - [RE-ZERO]** (+) key... Changes the value of the selected (blinking) digit.
 - [MODE]** (-) key... Changes the value of the selected (blinking) digit.
 - [SAMPLE]** key... Selects the digit to blink.
 - [PRINT]** key... Stores the set value and goes to the next item.
 - [CAL]** key... Goes to the next item without storing the set value.
9. Press the **[PRINT]** key to go to the next item.
10. Press the **[CAL]** key to return to weighing mode.

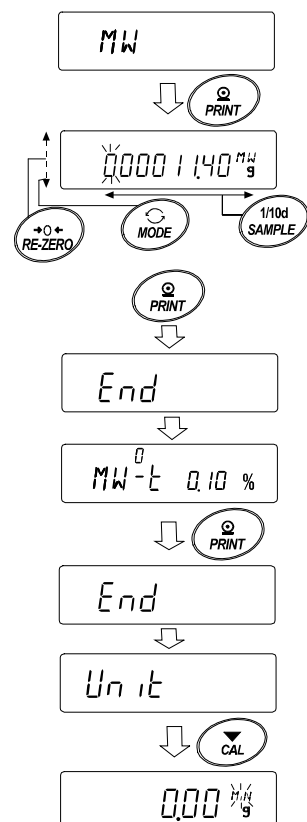

15-2-2 Procedure To Set In The Weighing Display (With Balance Software Version 1.200 To 1.220)

1. In weighing mode, press the **MODE** key.
2. The currently set minimum weighing value displays blinking.
3. Press the **PRINT** key.
4. Set the minimum weighing value.

The minimum weighing value can be changed with the following keys.

RE-ZERO (+) key... Changes the value of the selected (blinking) digit.

MODE (-) key... Changes the value of the selected (blinking) digit.

SAMPLE key... Selects the digit to blink.

PRINT key... Stores the set value and goes to the next item.

CAL key... Goes to the next item without storing the set value.

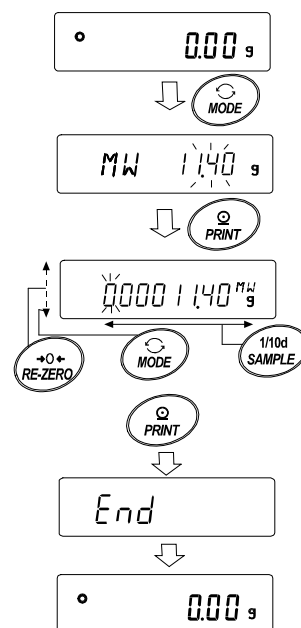

15-2-3 Procedure To Set In The Function Table (With Balance Software Version 1.300 Or Later)

Direct Input of the minimum weighing value

Continued from step 6 of "15-1 Minimum Weighing Value Comparison".

7. With **MW** displayed, press the **PRINT** key.
8. **KEY in** is displayed.

To set the minimum weighing value, press the **PRINT** key again and go to step 9.

To return to weighing mode without setting the minimum weighing value, press the **CAL** key twice. The balance returns to weighing mode without inputting the minimum weighing value.

9. Set the minimum weighing value.

The minimum weighing value can be changed with the following keys.

RE-ZERO (+) key... Changes the value of the blinking digit.

MODE (-) key... Changes the value of the blinking digit.

SAMPLE key... Selects the digit to blink.

PRINT key... Stores the set value and goes to the next item.

Note that the parameter is automatically set to

"1" (excluding near zero) when "MW-CP" is set to "0", and the minimum weighing value comparison function is enabled.

CAL key... Goes to the next item without storing the set value.

10. Press the **CAL** key to return to weighing mode.

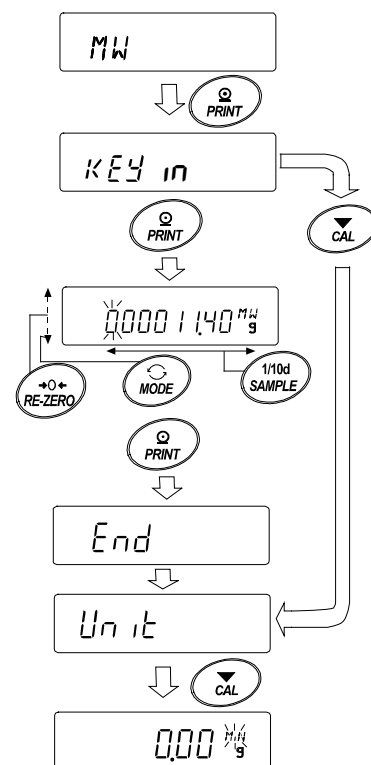

Input using repeatability with an external weight

Continued from step 6 of "15-1 Minimum Weighing Value Comparison".

7. With **MW** displayed, press the **PRINT** key to display **KEY in**.
8. Press the **SAMPLE** key to display **EXT MASS**.
9. Press the **PRINT** key.
START, **READY**, and weighing display appear, and then **LOAD** is displayed requesting the first load for repeatability.
10. Place an external weight on the weighing pan. The processing indicator (◀) lights.
11. The processing indicator (◀) starts blinking when processing is stabilized. When it remains stable for 2 seconds, the span is displayed.
12. **REMOVE** displays blinking.
13. Remove the external weight. The processing indicator (◀) lights.
14. The processing indicator (◀) starts blinking when processing is stabilized. When it remains stable for 2 seconds, the zero is displayed.
15. **LOAD** is displayed requesting the second load for repeatability. After that, perform repeatability measurement up to the 10th time.
16. After the 10th span is displayed, **REMOVE** and **End** appear, and then **MW 23.20 g** is displayed showing the minimum weighing display.

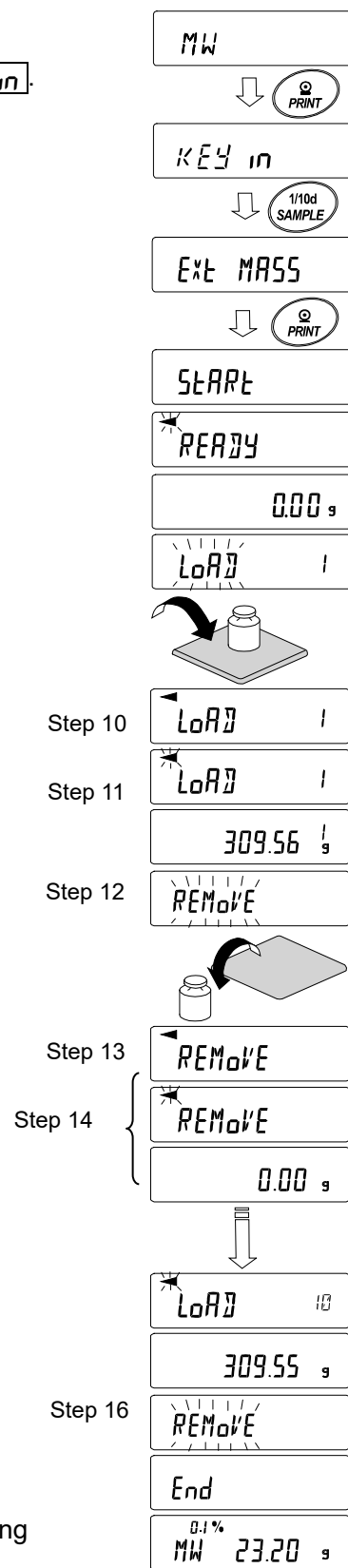

About error messages

E g Load exceeding the capacity is applied.

- E g Not enough load is applied.

Note that you are returned to repeatability measurement when the above errors are cleared.

Error 1 Weighing value unstable (approx. for 20 seconds) during repeatability measurement,

Timeout (after approx. 2 minutes of inactivity).

Note that after **Error** is displayed the balance will force end repeatability measurement and return to the function table.

17. The repeatability (5 \bar{D}) and minimum weighing value (MW) can be selected and output.

When $MW^{0.1\%} 23.20\text{ g}$ is displayed, press the **SAMPLE** key to switch between the minimum weighing value (MW) and repeatability (5 \bar{D}).

Press the **MODE** key to switch the measurement tolerance.

[Example of minimum weighing value batch output]

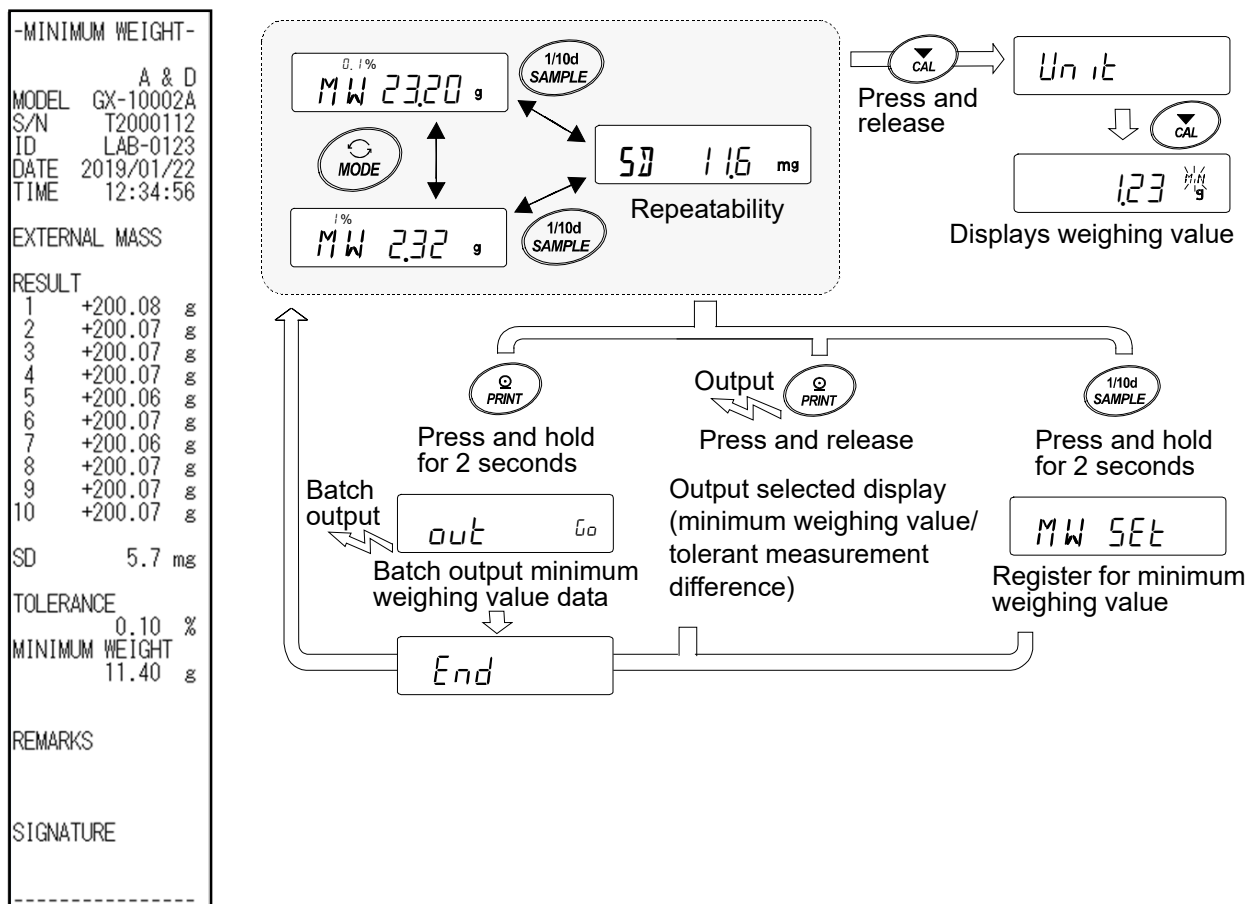

18. Press the **PRINT** key to output the display selected in step 17 (repeatability "5 \bar{D} " / minimum weighing value "MW").

Press and hold the **PRINT** key for 2 seconds to output data in batch.

19. When the output is completed, $MW^{0.1\%} 23.20\text{ g}$ appears.

20. Press and hold the **SAMPLE** key for 2 seconds to store the minimum weighing value and return to $MW^{0.1\%} 23.20\text{ g}$.

Note that the parameter is automatically set to "I" (excluding near zero) when "MW-CP" is set to "0", and the minimum weighing value comparison function is enabled.

21. Press the **CAL** key twice to start the minimum weighing warning function in weighing mode.

15-2-4 Procedure To Set In The Weighing Mode (Balance Software Version 1.300 Or Later)

1. Press the **MODE** key in weighing mode.
2. When **MW 23.20^{KEY}g** is displayed, press the **PRINT** key.
3. **KEY in** is displayed.

After this, perform the minimum weighing value setting from step 8 of "Direct input of the minimum weighing value" or step 8 of "Input using repeatability with an external weight" in "15-2-3 Procedure To Set In The Function Setting".

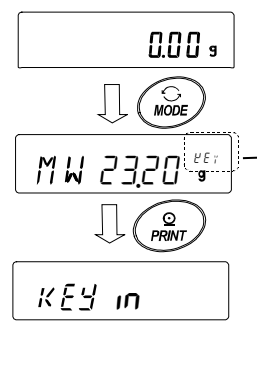

Currently set value is displayed above unit

KEY Set value input

EXT Input using repeatability with an external weight

ECL Input with ECL (press and hold the MODE key).

Refer to "6-2 Self Check Function / Automatic Setting Of Minimum Weighing Value By ECL".

15-2-5 Procedure To Output The Settings In Batch (Balance Software Version 1.300 Or Later)

The set minimum weighing value and repeatability result can be output in batch.

1. With **KEY in** or **EXT MASS** displayed, press and hold the **PRINT** key for 2 seconds.
2. Pressing the **REZERO** key toggles between "No" and "Lo" of the **out** display. Select "Lo" and press the **PRINT** key to output the settings in batch.
3. When the batch output is completed, **End** appears and then the display returns to **KEY in** or **EXT MASS**.

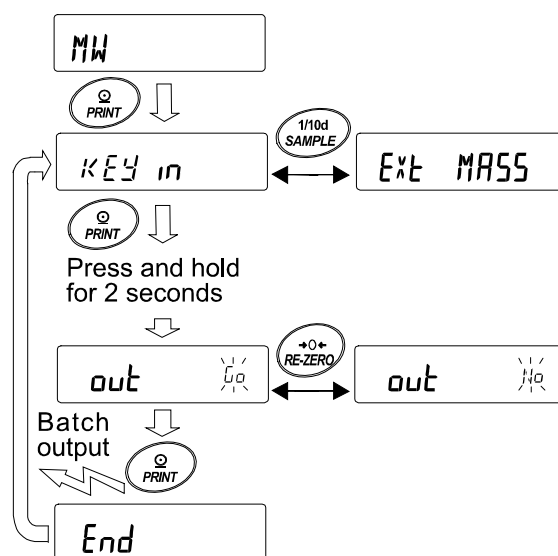

[Example of batch output of the set minimum weighing value]

The output content depends on the minimum weighing value setting method.

Set with **KEY IN**

```
-MINIMUM WEIGHT-
      A & D
MODEL  GX-10002A
S/N    T2000112
ID     LAB-0123
DATE   2019/01/22
TIME   12:12:34

KEY INPUT

MINIMUM WEIGHT
      11.40 g

REMARKS

SIGNATURE
-----
```

Set with **EXT MASS**

```
-MINIMUM WEIGHT-
      A & D
MODEL  GX-10002A
S/N    T2000112
ID     LAB-0123
DATE   2019/01/22
TIME   12:34:56

EXTERNAL MASS

RESULT
 1  +200.08 g
 2  +200.07 g
 3  +200.07 g
 4  +200.07 g
 5  +200.06 g
 6  +200.07 g
 7  +200.06 g
 8  +200.07 g
 9  +200.07 g
10  +200.07 g

SD      5.7 mg

TOLERANCE
      0.10 %
MINIMUM WEIGHT
      11.40 g

REMARKS

SIGNATURE
-----
```

Set with ECL

```
-MINIMUM WEIGHT-
      A & D
MODEL  GX-10002A
S/N    T2000112
ID     LAB-0123
DATE   2019/01/22
TIME   12:51:55

ECL

RESULT
 1  +20.07 g
 2  +20.06 g
 3  +20.06 g
 4  +20.06 g
 5  +20.05 g
 6  +20.06 g
 7  +20.05 g
 8  +20.06 g
 9  +20.06 g
10  +20.06 g

SD      5.7 mg

TOLERANCE
      0.10 %
MINIMUM WEIGHT
      11.40 g

REMARKS

SIGNATURE
-----
```

15-3. Setting Measurement Tolerance Of Minimum Weighing Value

With the function table "MW-L" setting, the measurement tolerance can be selected for the minimum weighing value (reference value) that is calculated based on repeatability measurement with electronically controlled load (ECL).

This function is available with balance software version 1.200 to 1.220.

For balance software version 1.300 or later, in order to perform setting, refer to "Input using repeatability with an external weight" in "15-2 Input And Output Of The Minimum Weighing Value" or refer to "6-2 Self Check Function / Automatic Setting Of Minimum Weighing Value By ECL".

Setting procedure

1. Press and hold the **SAMPLE** key for 2 seconds to display **bASFnC** of the function table.
2. Press the **SAMPLE** key several times to display **MWFnC**.
3. Press the **PRINT** key.
4. Press the **SAMPLE** key several times to display **MW-L**.
5. Press the **RE-ZERO** key to select **MW-L 0.10 %** (standard deviation SDx2000 times) or **MW-L 1 %** (standard deviation SDx200 times).
6. Press the **PRINT** key to go to the next item.
7. Press the **CAL** key to return to the weighing display.

For repeatability measurement with the set value of electronically controlled load (ECL), refer to "6-2 Self Check Function / Automatic Setting Of Minimum Weighing Value By ECL".

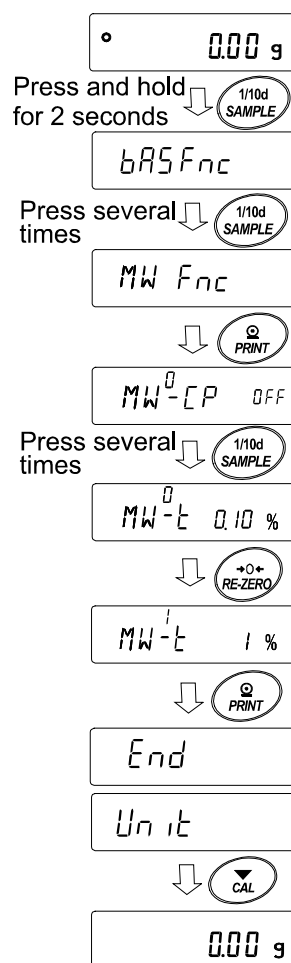

15-4. Data Output When Less Than Minimum Weighing Value

Output of data below the minimum weighing value can be switched ON/OFF with the "Min out" setting of the function table.

This function is available with balance software version 1.200 or later.

Setting procedure

1. Press and hold the **SAMPLE** key for 2 seconds to display **bASFnC** of the function setting.
2. Press the **SAMPLE** key several times to display **MWFnC**.
3. Press the **PRINT** key.
4. Press the **SAMPLE** key several times to display **Min out**.
5. Press the **RE-ZERO** key to select **Min out ON** (data output ON) or **Min out OFF** (data output OFF)
6. Press the **PRINT** key to go to the next item.
7. Press the **CAL** key to return to weighing mode.

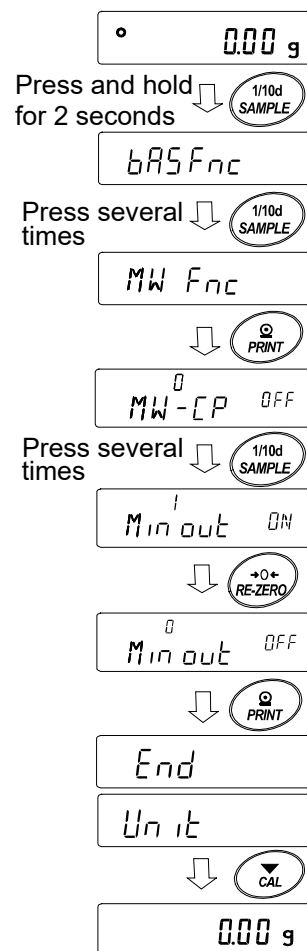

16. Underhook

The built-in underhook is used for underhook weighing such as measurement of magnetic materials or density measurement.

To use the underhook, open the cap on the bottom of the balance as shown below.

Caution

- Do not apply excessive force to the underhook part.
- Do not open the cap unless necessary. (For protection from dust)
- The underhook can be used only in the hanging direction (pulling direction).

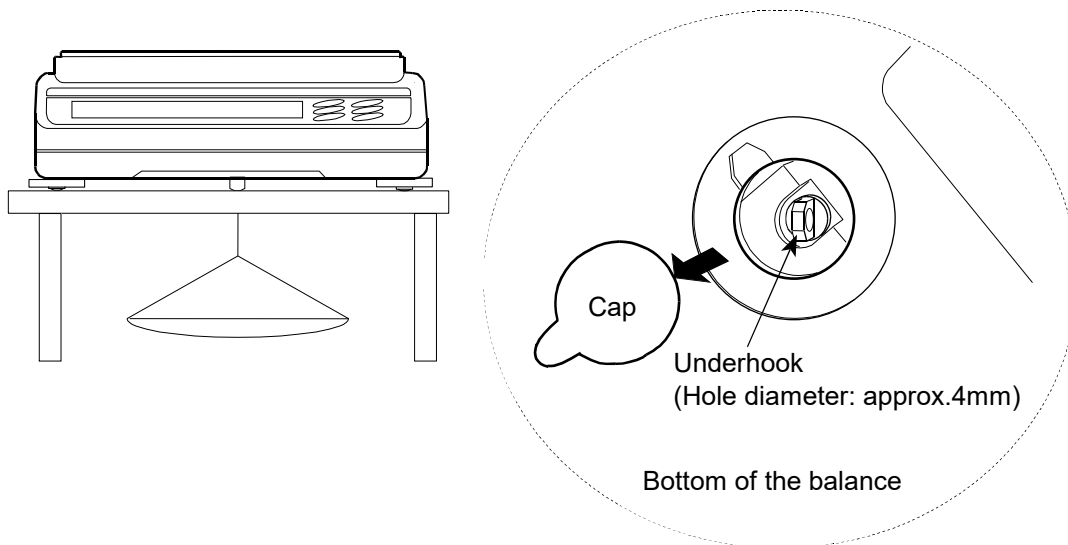

- If the balance is tilted greatly, attached parts such as the weighing pan will come off. Please remove them before work.
- Keep in mind that draft enters the balance easily when the underhook cap is removed, affecting the weighing values.

17. Programmable Unit

This is a programmable unit conversion function. It multiplies the weighing data in grams by an arbitrary coefficient set in the function table and displays the result.

The coefficient must be within the range between the minimum and maximum shown below. The setting of coefficient differs according to the balance software version. If the coefficient set is beyond the range, an error is displayed and the balance returns to the coefficient setting mode, prompting to enter an appropriate value. A coefficient of 1 was set at the factory.

Balance software version 1.200 to version 1.220

Model	Minimum coefficient	Maximum coefficient
GF-123A GX/GF - 203A/303A/403A/603A/1003A/1603A/ 203AWP/303AWP/403AWP/603AWP	0.01	1000
GF-1202A GX/GF - 2002A/3002A/4002A/6002A/10002A/ 2002AWP/3002AWP/4002AWP/6002AWP		100
GX/GF - 6001A/10001A/6001AWP		10

Balance software version 1.300 or later

Model	Minimum coefficient	Maximum coefficient
GX-124AE/224AE/324AE GX/GF - 124A/224A/324A	0.000001	10000
GF-123A GX/GF - 203A/303A/403A/603A/1003A/1603A/ 203AWP/303AWP/403AWP/603AWP		1000
GF-1202A GX/GF - 2002A/3002A/4002A/6002A/10002A/ 2002AWP/3002AWP/4002AWP/6002AWP		100
GX/GF - 6001A/10001A/6001AWP		10

Operation

1. Press and hold the **SAMPLE** key until **bR5FnC** of the function table is displayed.
2. Press the **SAMPLE** key several times to display **MLE**.
3. Press the **PRINT** key. The balance enters the mode to confirm or set the coefficient.

Confirming the coefficient

4. The current coefficient is displayed with the first digit blinking.
 - When it is not to be changed, press the **CAL** key to go to step 6.
 - When it is to be changed, press the **RE-ZERO** key to go to step 5.

Setting the coefficient

5. Set the coefficient with the following keys.

SAMPLE key Selects the digit to change the value. The selected digit blinks.

RE-ZERO key Changes the value.

MODE key Changes the decimal point position. Each time the switch is pressed, the decimal point position changes as follows:

→ 0.000001 → 00.00001 → ... → 000000.1 → 0000001

PRINT key Stores the new value, displays **End** and goes to step 6.

CAL key Cancels the new value and goes to step 6.

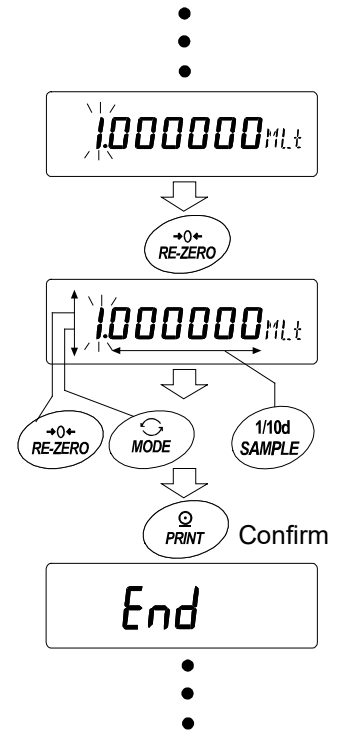

Quitting the operation

6. The balance displays **Unit**. Press the **CAL** key to exit the programmable unit function and return to the weighing mode.

Using the function

Press the **MODE** key to select the programmable unit (no display on the unit section).

Perform weighing as described in “4-2 Basic Operation (Gram Mode)”. After weighing, the balance displays the result (weighing data in grams x coefficient).

18. Density (Specific Gravity) Measurement

The balance is equipped with a density mode. It calculates the density of a solid according to the sample weight in air and sample weight in liquid.

For density measurement, the optional GXA-13 Density Determination Kit is recommended.

Note

- The density mode is disabled by default. To use the density mode, the function table needs to be changed in order to enable the density mode "d5". Please refer to "Storing Units" in "4-1 Units".
- Readability is fixed in density mode.

Density formula

1. Density of a solid

The density of a solid can be obtained according to the sample weight in air, sample weight in liquid and the density of the liquid.

$$\rho = \frac{A}{A-B} \times \rho_0$$

ρ : Density of sample A: Sample weight in air
 ρ_0 : Density of liquid B: sample weight in liquid

2. Density of a liquid

The density of a liquid can be obtained according to the weight of the float in air, the weight of the float in a liquid, and the known volume of the float.

$$\rho = \frac{A-B}{V}$$

ρ : Density of sample A: Weight of the float in air
 V : Volume of the float B: Weight of the float in liquid

(1) Preparing for measurement (Changing the function table)

Prior to measurement, change the function table as follows:

1. Register the density mode. The density mode cannot be used with the factory settings. Refer to "Storing Units" in "4-1 Units" to register the density mode (d5). The density mode can be selected as a unit with the **[MODE]** key.
2. Select either solid or liquid as the sample to be measured. (Function table *d5 Fnc*, *d5*)
3. For solid density measurement, select a liquid density input method. (Function table *d5 Fnc*, *Ld in*). For liquid density setting, select as the input method either input according to the water temperature or direct input of density with the function table below.
4. With the weighing display of the balance, press the **[MODE]** key to display the density measurement display in order to start measurement.

For measurement procedure, refer to (2) Measuring the density of a solid / (4) Measuring the density of a liquid.

Note

- The following density function table (*d5 Fnc*) cannot be displayed unless the density mode is enabled. Make sure to perform registration of the density mode in the unit setting (*Unit*) of the function table first. When the density mode is enabled, "d5 Fnc" is displayed after "Unit". To change the function table, refer to "9. Function Table".

Class	Item and parameter	Description	
<i>d5 Fnc</i> Density function	<i>Ld in</i> Liquid density input	■ []	Water temperature
		[/]	Liquid density
	<i>d5</i> Sample selection	■ []	Solid density measurement
		[/]	Liquid density measurement

■ Factory setting

(2) Measuring the density (specific gravity) of a solid (Function table d5 0)

Note

- If temperature of the liquid changes during measurement or when type of liquid is changed, reset the density of a liquid by "(3) Inputting the density of a liquid" as necessary. In density display, the 3 digits (4 digits for 0.0001g models) after the decimal point are fixed. The readability cannot be changed with the **[SAMPLE]** key.

In density measurement, the density is fixed and displayed according to weight in air measurement and weight in liquid measurement.

The relationship between each state and display is as follows.

Measurement procedure

- In weight in air measurement mode (g lights, \blacktriangleleft blinks), press the **[RE-ZERO]** key to display zero with nothing on the weighing pan.
- Place a sample on the weighing pan in air and wait for the display to stabilize. To output the sample weight, press the **[PRINT]** key. Next, press the **[SAMPLE]** key to confirm the weight in air and enter weight in liquid measurement mode (g lights, \blacktriangleleft lights).
If auto-zero after data output (d5-d) is set to on in the function table, pressing the **[PRINT]** key to output will trigger auto reset after the output, and thus prevent the density measurement.
- Transfer the sample from the weighing pan in air to the weighing pan in liquid and wait for the display to stabilize. To output the sample weight, press the **[PRINT]** key. Next, press the **[SAMPLE]** key to confirm the weight in liquid and enter density input mode (g turns off, \blacktriangleleft lights).
- Input the density of the liquid.
Set the density by referring to "(3) Inputting of liquid density".
Next, press the **[PRINT]** key to enter density mode. (g turns off, \blacktriangleleft lights).
- To output the density, press the **[PRINT]** key. To measure another sample, press the **[SAMPLE]** key and start with weight in air measurement mode. The density unit is "d5".
- If temperature of the liquid changes during measurement or when type of liquid is changed, reset the density of the liquid with "(3) Inputting the density of a liquid" as necessary.
- Press the **[MODE]** key to enter weighing mode.

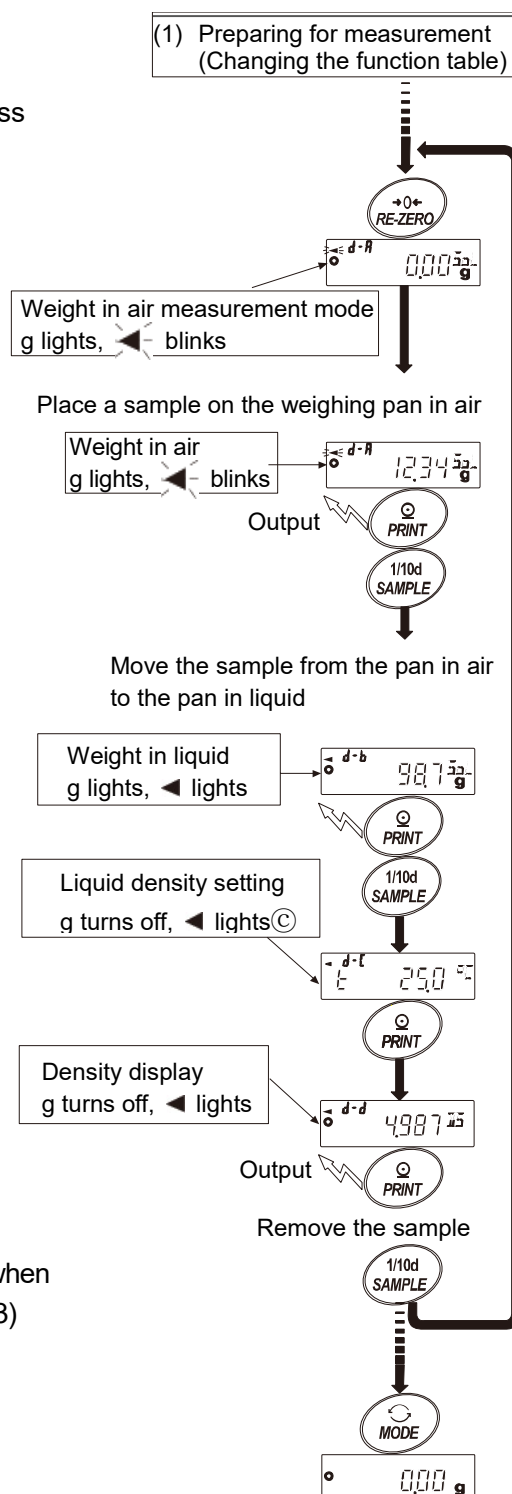

(3) Inputting the density of a liquid

With "Liquid density input (Ld_{in})" of the function table, water temperature input mode or density input mode is selected as described below.

Water temperature input mode (Ld_{in})

The currently set water temperature (unit: °C, factory setting: 25°C) is displayed.

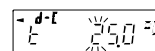

The set water temperature can be changed with the following keys. Set a value between 0.0°C and 99.9°C, with 0.1°C increments. Refer to the correspondence table of water temperature and density below.

RE-ZERO (+) key ..Changes the value of the selected (blinking) digit.
(0 appears next to 9.)

MODE (-) key.....Changes the value of the selected (blinking) digit.
(9 appears next to 0.)

SAMPLE keySelects the digit to blink.

PRINT keyStores the set value and enters density display mode. (To step 5 on the previous page)

CAL key Enters density mode without storing the set value. (To step 5 on the previous page)

Correspondence table of water temperature and density

°C	+0	+1	+2	+3	+4	+5	+6	+7	+8	+9
0	0.99984	0.99990	0.99994	0.99996	0.99997	0.99996	0.99994	0.99990	0.99985	0.99978
10	0.99970	0.99961	0.99949	0.99938	0.99924	0.99910	0.99894	0.99877	0.99860	0.99841
20	0.99820	0.99799	0.99777	0.99754	0.99730	0.99704	0.99678	0.99651	0.99623	0.99594
30	0.99565	0.99534	0.99503	0.99470	0.99437	0.99403	0.99368	0.99333	0.99297	0.99259
40	0.99222	0.99183	0.99144	0.99104	0.99063	0.99021	0.98979	0.98936	0.98893	0.98849

g/cm³

Density input mode (Ld_{in})

The currently set density (unit: g/cm³, factory setting: 1.0000g/cm³) is displayed.

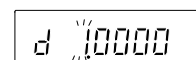

The set density can be changed with the following keys.

Set a value between 0.0000g / cm³ and 1.9999g / cm³. If a value outside this range is input, **Error** is displayed and the display returns to the input display.

RE-ZERO (+) key.... Sets the value of the selected (blinking) digit. (0 appears next to 9)

MODE (+) key..... Sets the value of the selected (blinking) digit. (9 appears next to 0)

SAMPLE keySelects the digit to blink.

PRINT keyStores the set value and enters density mode. (To step 5 on the previous page)

CAL keyEnters density mode without storing the set value. (To step 5 on the previous page.)

(4) Measuring the density (specific gravity) of a liquid (Function table d51)

Note

- In density display, the 3 digits (4 digits for 0.0001g models) after the decimal point are fixed. The readability cannot be changed with the **[SAMPLE]** key.

In density measurement, the density is fixed and displayed according to float weight in air measurement and float weight in liquid measurement.

The relationship between each state and display is as follows.

Measurement procedure

- In weight in air measurement mode (g lights, \blacktriangleleft blinks), place nothing on the pan and press the **[RE-ZERO]** key to display zero.
- Place the float and wait for the display to stabilize.
To output the float mass value, press the **[PRINT]** key.
Next, press the **[SAMPLE]** key to confirm the weight in air and enter weight in liquid measurement mode. (g lights, \blacktriangleleft blinks)
If auto-zero after data output (β_{r-d}) is set to on in the function table, pressing the **[PRINT]** key to output will trigger auto reset after the output, and thus prevent the density measurement.
- Put the liquid in the beaker and sink the float in order to measure the density.
At this time, adjust so that the float is about 10 mm below the liquid level.
- Wait for the display to stabilize.
To output the sample mass value, press the **[PRINT]** key.
Next, press the **[SAMPLE]** key to confirm the weight in liquid and enter volume input mode. (g turns off, cm^3 lights, \blacktriangleleft lights)
- Input the volume of the float.
Input the volume by referring to "(5) Inputting the volume of the float". Next, press the **[PRINT]** key to enter density display mode.
- To output the density, press the **[PRINT]** key
To measure another sample, press the **[SAMPLE]** key and start from weight in air measurement mode.
The density unit is "g".
- Press the **[MODE]** key to enter weighing mode.

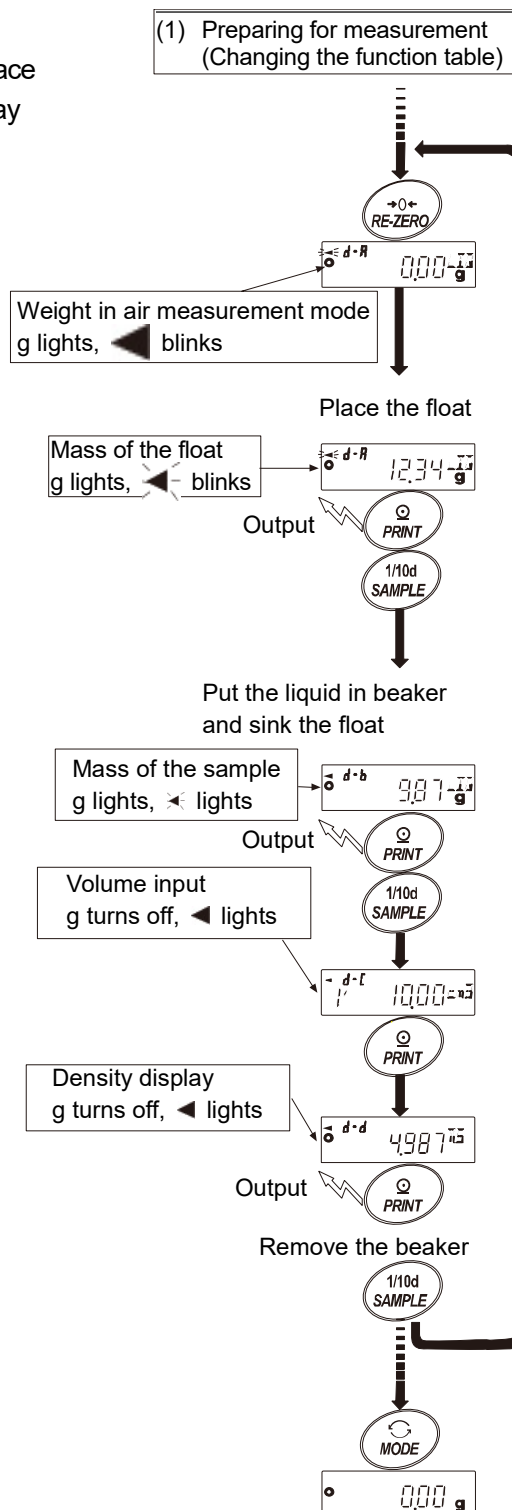

(5) Inputting the volume of the float

The currently set volume of the float is displayed. (Factory setting is 10.00cm³)

The set value can be changed with the following keys.

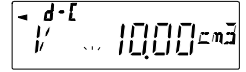

Set a value between 0.01 cm³ and 99.99 cm³, with 0.01 cm³ increments.

RE-ZERO (+) KeyChanges the value of the selected (blinking) digit.
(0 appears next to 9.)

MODE (-) keyChanges the value of the selected (blinking) digit.
(9 appears next to 0.)

SAMPLE keySelects the digit to blink.

PRINT keyStores the set value and enters density display mode. (To step 5 on the previous page.)

CAL key Enters density display mode without storing the set value. (To step 5 on the previous page.)

19. Password Lock Function

With the password lock function, it is possible to restrict the use and functions of the balance, which is effective in preventing falsification of date and time settings and also preventing internal setting change by the user.

The password is set with four digits/keys (**MODE**, **SAMPLE**, **PRINT** and **RE-ZERO**) and four options ($4 \times 4 \times 4 \times 4 = 256$ combinations).

The password lock function is disabled by default. To enable/disable the password lock function and register a new password, make changes in the function table.

Note

The function varies depending on the balance software version.

19-1. Balance Software Version 1.200

The function can be set in two ways with the "Lock" setting of "Password lock function (PASSWD)" in the function table.

Lock 0	No password lock function
Lock 1	Password required at the start of weighing

Lock 0 (No password lock function)

The password lock function is not used.

All functions of the balance can be used by anyone in weighing operation and settings can be changed.

Lock 1 (Password required at the start of weighing)

Administrator (ADMIn.) can limit users of the balance by setting individual passwords.

(The password will be required to start weighing with the **ON:OFF** key.)

Unless the correct password is entered, the balance cannot enter weighing mode.

There are two login levels: Administrator (ADMIn.) and User (OPRt. to I0)

Administrator (ADMIn.)	All functions and settings are available.
	Passwords for 10 users can be set individually.
User (OPRt. to I0)	Initialization and setting changes are restricted (including clock).
No password	The balance cannot be used.

Restricted items according to login level

Login level	Weighing		
	Password input at the start of weighing	Sensitivity adjustment	Function setting *4
Administrator (ADMIn.)	Available	Available	Available
User (OPRt. to I0)	Available	Not available	Not available

*4 Response adjustment, minimum weighing value setting, function selection and initialization, and function table (clock & calendar setting)

19-2. Balance Software Version 1.211 Or Later

The function can be set in three ways with the "Lock" setting of "Password lock function (PASSwd)" in the function table

Lock 0	No password lock function
Lock 1	Password required at the start of weighing
Lock 2	Login with administrator password required when settings are changed

Lock 0 (No password lock function)

The password lock function is not used.

All functions of the balance can be used by anyone in weighing operation and settings can be changed.

Lock 1 (Password required at the start of weighing)

Administrator (ADMIN) can limit the users of the balance by setting individual passwords.

(The password will be required to start weighing with the key.)

Unless the correct password is entered, the balance cannot enter weighing mode.

There are two login levels: Administrator (ADMIN) and User (USER 01 to 10)

Administrator (ADMIN)	All functions and settings are available.
	Passwords for 10 users can be set individually.
User (USER 01 to 10)	Initialization and setting changes are restricted (including clock).
No password	The balance cannot be used.

Lock 2 (Login with administrator password required when settings are changed)

Weighing can be operated by anyone, but initialization and setting change (including clock) are restricted.

(The password will not be required to start weighing with the key.)

There are two login levels: Administrator (ADMIN) and Guest (GUEST)

Administrator (ADMIN)	All functions and settings are available.
Guest (GUEST)	Initialization and setting change (including clock) are restricted.

If you press the key while holding down the key to start weighing when the display is off, you will be prompted to enter the administrator password (ADMIN).

Restricted items according to login level

Login level	Weighing		
	Password input at the start of weighing	Sensitivity adjustment	Function change *5
Administrator (ADMIN)	Required	Available	Available
User (USER 01 to 10)		Available *6	Not available
Guest (GUEST)	Not required		

*5 Response adjustment, minimum weighing value setting, repeatability check with the internal mass, function selection and initialization, and function table (clock & calendar setting)

*6 Administrator (ADMIN) can prohibit it with the setting procedure in "8-1 Permit Or Inhibit".

19-3. Enabling Password Lock Function

With "password function (*PASSwd*)" of the function table, the password function can be switched between "Disabled (*OFF*)", "Enabled (*ALL*)", and "Enabled (*Fnc*)".

1. In the weighing mode, press and hold the **SAMPLE** key for 2 seconds to display **bASFnC**.
2. Press the **SAMPLE** key several times to display **PASSwd**.
3. Press the **PRINT** key to display **Lock OFF**.
(To cancel, press the **CAL** key.)
4. Press the **RE-ZERO** key to display **Lock ALL**.
(Press the **RE-ZERO** key again to display **Lock Fnc**.)
5. Press the **PRINT** key to display **SUrE: YES**.
("No" is blinking while it is selected.)
6. Press the **RE-ZERO** key to switch **YES / No**.
7. Display **SUrE: YES**. (**YES** is blinking while it is selected.)
8. When **YES** is selected, press the **PRINT** key to enable the password lock function.
(With "**Lock I**" setting, you will be prompted to enter the password when the display turns on.)
9. **PASS No** is displayed.
To register (change) a password, go to step 4 of "19-6 Registering (Changing) Password".
To return to weighing mode without registering (changing) a password, press the **CAL** key twice.

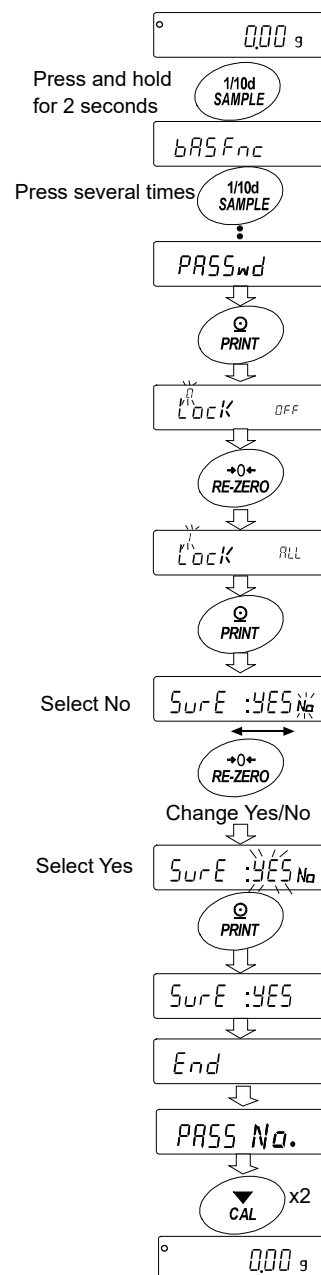

Note

With the balance software version 1.200, either "Disabled (*OFF*)" or "Enabled (*ON*)" can be selected.

19-4. Entering The Password At The Start Of Weighing

Lock 1 (Password required at the start of weighing)

1. With the display turned off, press the **ON:OFF** key.
2. After **password** is displayed, the password input display appears.
3. Enter a 4-digit password using the following keys.
 - MODE** keyEnters "M"
 - SAMPLE** keyEnters "S"
 - PRINT** keyEnters "P"
 - RE-ZERO** keyEnters "1"
 - CAL** keyBack key

Note that the display will turn off after 10 minutes of inactivity.

4. When the correct password is entered, the login level, all segments and indicators, and weighing display are displayed in order.

To log in as Administrator, enter the administrator password. (The factory default password is set at administrator level to **7777**, which is set by pressing the **RE-ZERO** key four times.)

If the password is incorrect, **FAIL** is displayed and the buzzer sounds three times, and then the display turns off.

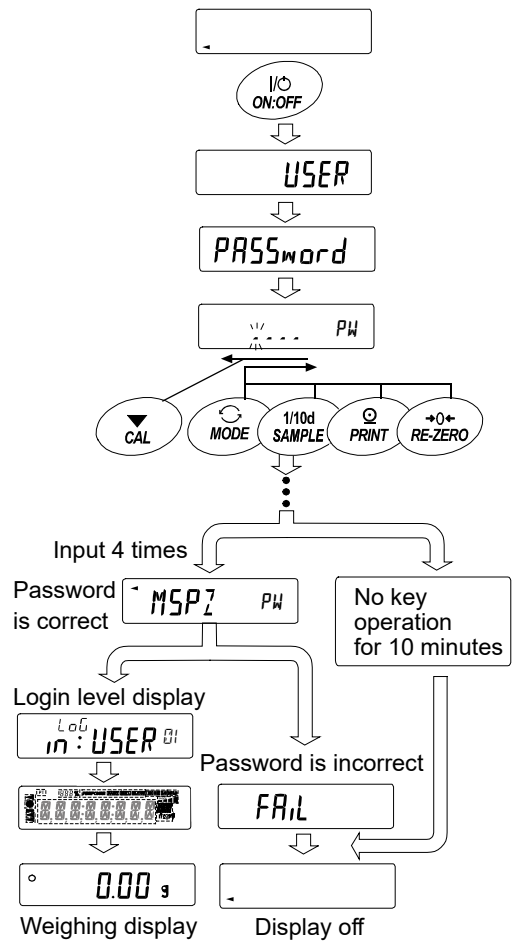

Lock 2 (Login with administrator password required when settings are changed)

- To log in as a Guest (**GUEST**), operate as follows.
1. With the display turned off, press the **ON:OFF** key.
 2. After **LOG in: GUEST** is displayed, the balance returns to weighing mode.

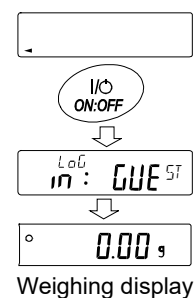

When logging in as Administrator (ADMIN.) (Lock 1 or Lock 2)

1. With the display turned off, press the **ON:OFF** key while holding down the **CAL** key.
2. Enter the 4-digit password using the following keys.

- MODE** key.....Enters "M"
- SAMPLE** key.....Enters "5"
- PRINT** keyEnters "P"
- RE-ZERO** keyEnters "7"
- CAL** keyBack key

Note that the display will turn off after 10 minutes of inactivity.

3. When the correct password is entered, the login level, all segments and indicators, and weighing display are displayed in order.
(The factory default password is set at administrator level to **7777**, which is set by pressing the **RE-ZERO** key four times.)

If the password is incorrect, **FAIL** is displayed and the buzzer sounds three times, and then the display turns off.

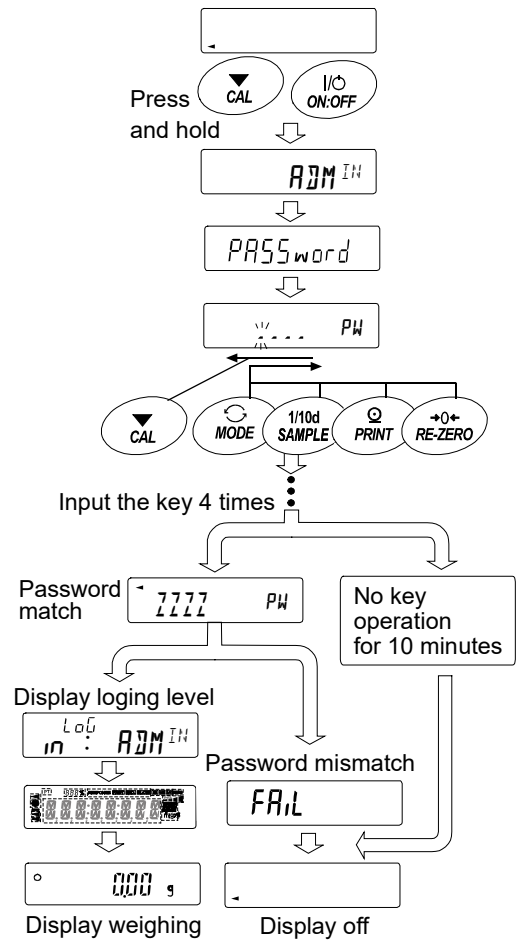

Note

With the balance software version 1.200, the login level is not displayed at logging in.
To log in as Administrator, enter the administrator password with "Lock 1" setting at the start of weighing.

19-5. Logging Out

You can log out by pressing the **ON:OFF** key to turn off the display.

With "Lock 1" setting, you will be prompted to enter the password again at the start of weighing when the display is turned off.

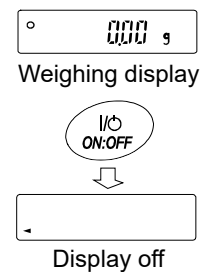

19-6. Registering (Changing) Password

The password can be changed with "Password (*PASS No.*)" of the function table.

1. In weighing mode, press and hold the **SAMPLE** key for 2 seconds to display **bASFnC**.
2. Press the **SAMPLE** key several times until **PASSwd** is displayed.
3. Press the **PRINT** key to display **Lock**.
4. Press the **SAMPLE** key to display **PASS No.**
5. Press the **PRINT** key to display **ADMIN.**
6. Press the **SAMPLE** key to select the login level (**ADMIN.** / **USER 01** to **10**) that you want to change. If the login level has a registered password already, the stability indicator lights. (It is possible to change.)
7. Press the **PRINT** key to change the password. Refer to "19-7 Changing Password".

Note

- You can log out by pressing the **ON:OFF** key to turn off the display.
- With "Lock 2" setting, the administrator (**ADMIN**) password is required at a log in as Administrator. Password registration for "**USER 01 ~ 10**" is not necessary.

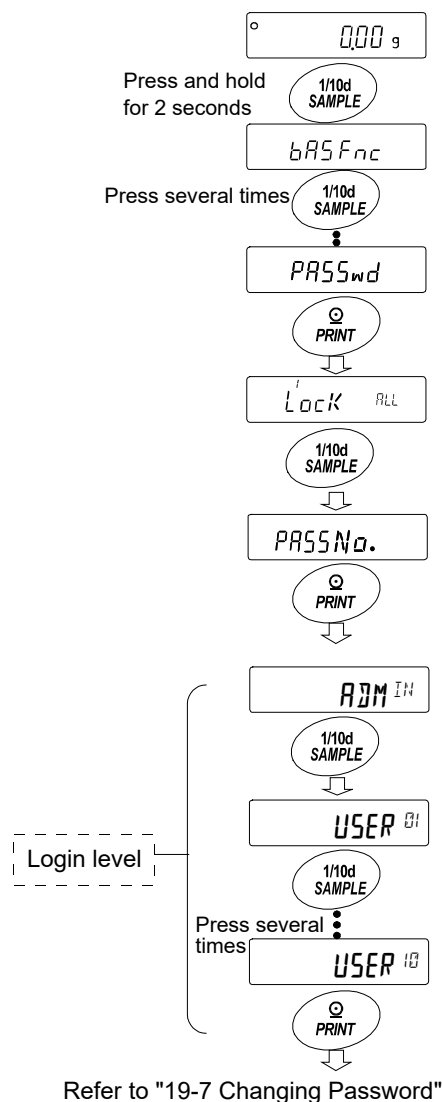

19-7. Changing Password

1. Refer to "19-6 Registering (Changing) Password" and display the login level at which you want to change the password.
2. Press the **PRINT** key to display the current password. (The factory default password is set at administrator level to **7777**, which is set by pressing the **RE-ZERO** key four times.)

3. Set a new password using the following keys:

MODE key Enters "M"

SAMPLE key..... Enters "5"

PRINT key Enters "P "

RE-ZERO key Enters "7"

CAL key..... Back key

CAL key (Press & hold)..Deletes password (Refer to "19-8 Deleting The Password "USER 01 to 10")

Note that the display will turn off after 10 minutes of inactivity.

4. When all four entries with the keys are completed, the new password is displayed.
5. **SURE: YES No** appears. ("No" is blinking while it is selected.)
(If you press the **CAL** key, the display returns to the 4th digit entry.)
6. Press the **RE-ZERO** key to display **SURE: YES No**. ("YES" is blinking when it is selected.)
7. With "YES" selected, press the **PRINT** key to store the new password.
8. When the setting is completed, the next level is displayed. To continue setting, operate from step 6. To finish setting, press the **CAL** key three times to return to weighing mode.

Refer to

"19-6 Registering (Changing) Password"

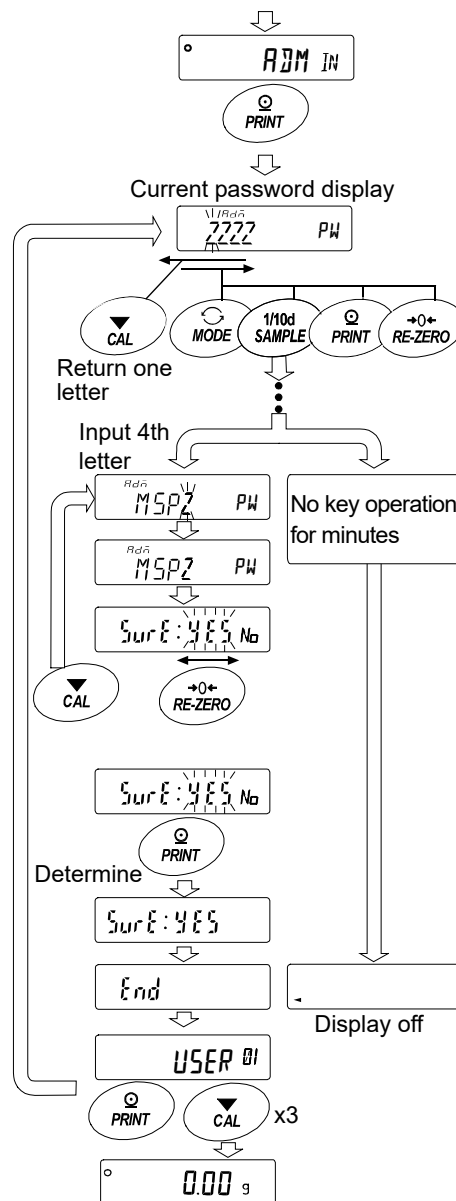

Note

- Be sure to record and keep the registered password. If the password is forgotten or lost, the balance cannot be used.
- The password that is already registered as the administrator (**ADMIN**) password cannot be registered as the user (**USER 01 to 10**) password.

19-8. Deleting Password (USER 01 to 10)

1. Refer to "19-7 Changing Password" to select the user (USER 01 to 10) whose password you want to delete and display the password entry display.
2. When entering the password, press and hold the **CAL** key for 2 seconds until **CLEAR** displays blinking.
3. Press the **PRINT** key to display **CLEAR No**.
4. Press the **RE-ZERO** key to toggle between "Go" and "No".
5. With **CLEAR Go** displayed, press the **PRINT** key. **End** appears and the password is deleted.

Note

- The administrator password cannot be deleted. Refer to "19-6 Registering (Changing) Password" and "19-7 Changing Password" to change it to an arbitrary password.

Refer to
"19-7 Changing Password"

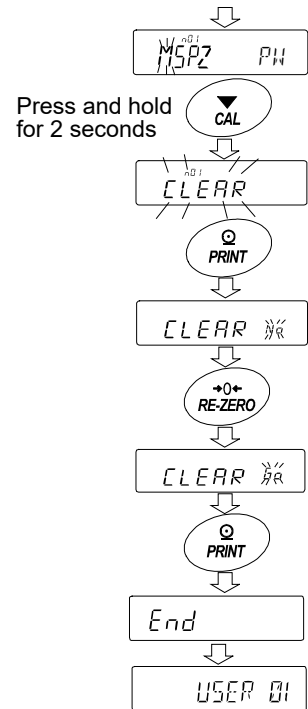

19-9. If Password Is Lost Or Forgotten

If the password is lost or forgotten, the balance cannot be used.
Contact your local A&D dealer to reset the password.

20. Repeatability Check Function (GX-AE/GX-A/GX-AWP Series Only)

Repeatability is an index of variation in measured values when the same mass is repeatedly loaded and unloaded, and is usually expressed as the standard deviation. (σ_{n-1}).

The GX-AE/GX-A/GX-AWP series have an internal mass.

With the repeatability check function, the balance obtains 10 measurement results using the internal mass and displays its standard deviation. It is possible to use this function with the installed balance in order to check the repeatability in the installation environment.

This function is available with balance software version 1.211 or later.

Example) "Standard deviation = 10.0 mg" shows that the results of repeated measurements of the same sample fall within the range of ± 10.0 mg with a frequency of about 68%.

1. In weighing mode, press and hold the **[SAMPLE]** key for 4 seconds. Release the key when **[rEP tEST]** is displayed.
2. When **[rEP tEST]** is displayed, data collection starts automatically. **[rEP]** is blinking while data is being collected. (To cancel it, press the **[CAL]** key. **[CANCEL]** appears and the balance returns to weighing mode.)
3. When data collection is completed, repeatability (standard deviation) is displayed.
4. Press the **[PRINT]** key to output repeatability (standard deviation).
5. Press the **[CAL]** key to return to weighing mode.

Note

- With this function, the balance uses its internal mass (about 190 g) in order to obtain results, which is different from the conditions for repeatability in "25. Specifications". Consider the result as a reference value.
- This function cannot be used with GX-124A and GX-124AE.
- In order to measure correct data, do not apply vibration or drafts while collecting data.
- When the password lock function is used, this function is only available with a login as Administrator (**ADMIN**).

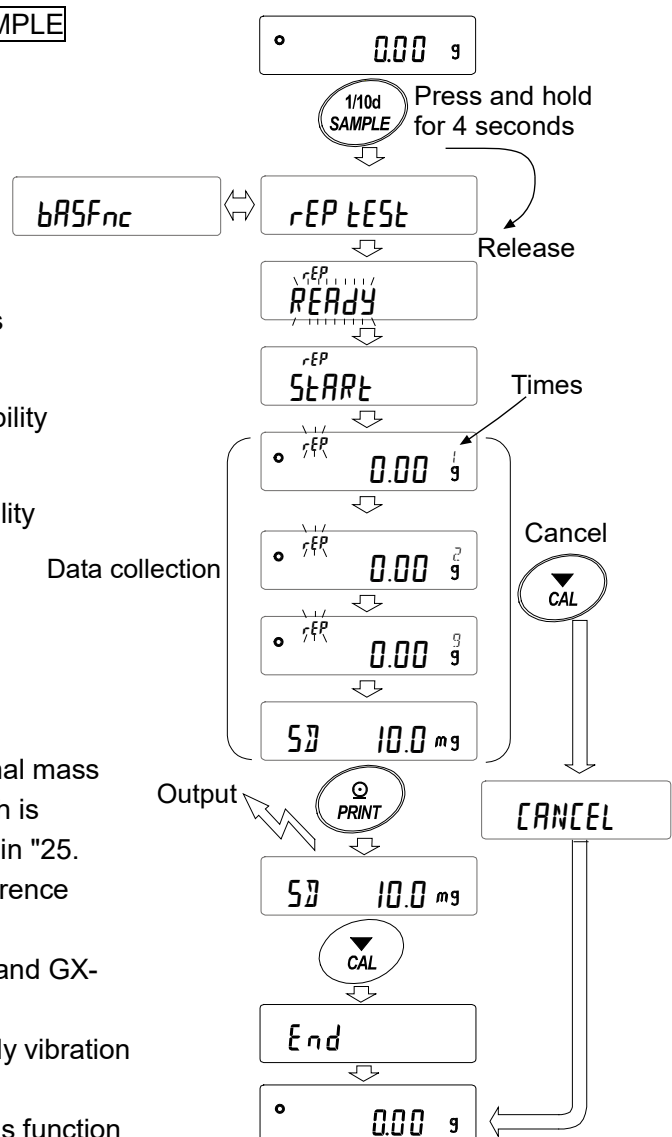

21. Interface Specification (Standard)

Download "Communication manual" from our website (<https://www.aandd.jp>) and refer to it.

22. Maintenance

22-1. Treatment Of The Balance

- Clean the balance with a lint free cloth that is moistened with warm water and a mild detergent.
- Do not use organic solvents or chemical cleaning cloths to clean the balance.
- Do not disassemble the balance.
- When transporting the balance, use the packing material and box that the balance was contained at the time of purchase. For transportation, remove the weighing pan and plate holder from the balance main body.

GX-AWP/GF-AWP specifications

- The GX-AWP/GF-AWP series dustproof and waterproof performance means it is waterproof in everyday situations, so the weighing pan can be washed with water while still installed.
Note that if the balance is submerged in water or if water pressure is applied to the bottom of the balance main body, water may get inside.
- When washing the balance with water, attach the terminal cover to the RS-232C interface or connect the waterproof RS-232C cable (AXKO2737-500).
Close the lid of the AC adapter input jack.
Make sure that the cover of the underhook is also closed.

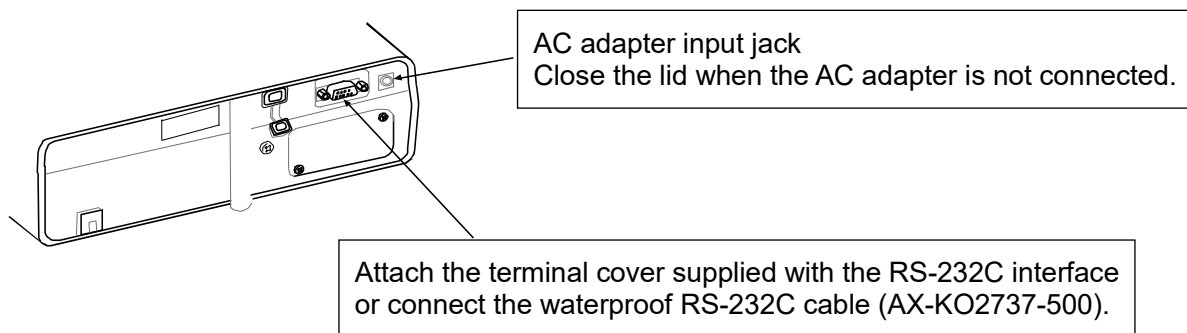

- If something such as water remains in the waterproof diaphragm, the weighing value may become unstable. Be careful not to deform the diaphragm when cleaning it.

23. Troubleshooting

23-1. Checking The Balance Performance And Environment

Since the balance is a precision instrument, in some cases it may not be able to measure correct values due to adverse effects of the measurement environment or measurement method. If repeatability is poor when the sample is loaded and unloaded several times, or if the balance seems to be operating abnormally, check the following items. If the problem persists after checking each item, contact your local A&D dealer for repair.

"Frequently Asked Questions" is also posted on our website (<https://www.aandd.jp>).

1. Check that the balance works properly.

- Check the operation of the balance using the self check function.
Refer to "6-2 Self Check Function / Automatic Setting Of Minimum Weighing Value By ECL".
A message will be displayed if there is a fatal failure.
- As a simpler test, check the repeatability with an external weight. Be sure to place the weight in the center of the weighing pan.
- As a precise test, check the repeatability, linearity, weighing value, etc. with a weight of a known weight.

2. Check that the measurement environment and method are appropriate.

Operating environment

- Is the weighing table solid enough? (Especially for the 0.0001g and 0.001g models)
- Is the balance level? For how to adjust the bubble spirit level, refer to "2-2 Precaution".
- Is the operating environment free from vibration and drafts?
- Is there any strong electrical or magnetic noise source such as a motor near the balance?









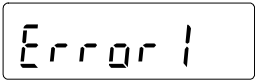

Weighing method

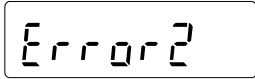
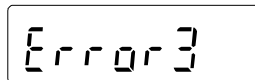



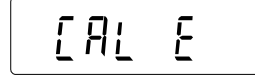

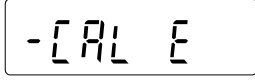
- Is the weighing pan set so that it does not touch other parts such as the breeze break and dust plate frame? (Is it installed correctly?)
- Do you always press the RE-ZERO key before placing your sample on the weighing pan?
- Do you place your sample in the center of the weighing pan?
- Did you perform a sensitivity adjustment before weighing?
- Did you connect the balance to the power supply for at least 1 hour to warm up before weighing?

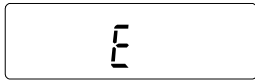
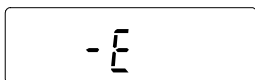
Sample and container

- Is the sample free from moisture absorption or evaporation due to the influence of ambient temperature and humidity?
- Is the temperature of the container of the sample acclimatized to the ambient temperature?
Refer to "2-3 During Use".
- Is the sample free of static electricity?
Refer to "2-3 During Use". (The sample may be charged with static electricity especially with 0.0001g and 0.001g models when the relative humidity is low.)
- Is the sample a magnetic material (iron, etc.)?
Care must be taken when weighing magnetic materials. Refer to "2-3 During Use".

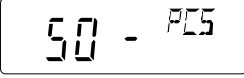
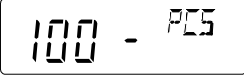
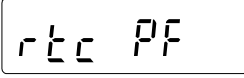
23-2. Error Codes

Display	Error code	Description
	EC, E11	Stability error The balance cannot stabilize due to an environmental problem. Check around the pan. Prevent vibration, drafts, temperature changes, static electricity and magnetic fields, from influencing the balance. Refer to "2-3 During Use". To return to the weighing mode, press the  key.
		Out of the setting range The data to be stored is out of the setting range. Set again within the setting range.
		Malfunction of the internal memory element of the balance If this error continues to be displayed, please ask for repair to your local dealer.
	EC, E16	Internal mass error Applying the internal mass does not yield a change in the mass value as specified. Confirm that there is nothing on the pan and perform the operation from the beginning again.
	EC, E17	Internal mass error The internal mass application mechanism does not function properly. Perform the operation from the beginning again.
		Abnormality in the internal memory data of the balance If this error continues to be displayed, please ask for repair to your local dealer.
		Abnormality in the internal memory data of the balance If this error continues to be displayed, please ask for repair to your local dealer.
	EC, E20	Sensitivity adjustment weight error (Positive value) The sensitivity adjustment weight is too heavy. Check around the pan. Check the mass value of the weight. To return to the weighing mode, press the  key.
	EC, E21	Sensitivity adjustment weight error (Negative value) The sensitivity adjustment weight is too light. Check around the pan. Check the mass value of the weight. To return to the weighing mode, press the  key.
		Overload error A sample beyond the balance weighing capacity has been placed on the pan. Remove the sample from the pan.
		Weighing pan error The mass value is too light. Check that the weighing pan is installed correctly. Set the weighing pan correctly. Adjust the sensitivity of the balance.

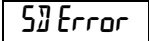
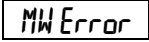
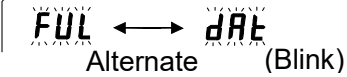
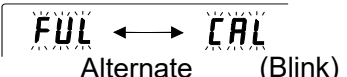
Display	Error code	Description
		Sample mass error The sample is too light to be stored as a sample mass for the counting mode or percent mode.
  		Unit mass error The sample unit mass for the counting mode is too light. Storing and using it for counting will cause a counting error. Add samples to reach the specified number and press the PRINT key. Pressing the PRINT key without adding samples will put the balance in the counting mode. But, for accurate counting, be sure to add samples.
		Clock battery error The clock backup battery has been depleted. Press any key and set the time and date. Even if the clock backup battery is depleted, the clock and calendar function works normally as long as the balance is powered with the AC adapter. If this error appears frequently, contact the local A&D dealer.
		Power supply voltage fault The voltage supplied from the AC adapter is abnormal. Please check if the problem is the AC adapter supplied with the balance.
 		ECL repeatability error With the self-check function, the standard deviation (SD) of repeatability with electronically controlled load (ECL) exceeded 50 digits. Review the installation environment of the balance.  Repeatability error  Minimum weighing value (reference value) error Refer to "6-2 Self Check Function / Automatic Setting Of Minimum Weighing Value by ELC."
		Full memory The number of stored weighing values has reached the upper limit. In order to store new weighing values, it is necessary to delete data. Refer to "11 Data Memory"
		Full memory The number of stored sensitivity adjustment/calibration test histories has reached 50. When new histories are added, older histories will be deleted. Refer to "11 Data Memory"
	EC, E00	Communications error A protocol error occurred in communications. Check the format, baud rate and parity.
	EC, E01	Undefined command error An undefined command was found. Check the transmitted command.

Display	Error code	Description
	EC, E02	<p>Not ready</p> <p>The received command cannot be executed.</p> <p>(e.g.) Q command was received when not in the weighing mode.</p> <p>(e.g.) Q command was received while rezeroing.</p> <p>Adjust the delay time to transmit a command.</p>
	EC, E03	<p>Timeout error</p> <p>With the timeout parameter set to "t_{-UP}", there was a wait time of approximately 1 second or more while receiving command characters. Check the communication.</p>
	EC, E04	<p>Character length error</p> <p>The number of characters in the received command has exceeded the limit.</p> <p>Check the command to transmit.</p>
	EC, E06	<p>Format error</p> <p>The description of the received command is incorrect.</p> <p>(e.g.) The number of digits of numerical values is incorrect.</p> <p>(e.g.) There are alphabet characters among the numerical values</p> <p>Check the transmitted command.</p>
	EC, E07	<p>Parameter setting error</p> <p>The value of the received command has exceeded the allowed value.</p> <p>Check the setting range of the numerical value of the command.</p>

23-3. Other Display



This is the automatic sensitivity adjustment notice (the ◀ mark blinking). If the balance is not used for several minutes with this mark blinking, the balance automatically performs sensitivity adjustment using the internal mass. The blinking period depends on the operating environment.

Advice Although it is possible to continue using the balance even while this mark is blinking, use after sensitivity adjustment is completed is advisable in order to maintain the weighing accuracy.

23-4. Asking For Repair

If the balance needs service or repair, please consult with your local A&D dealer.

The balance is a precision instrument. Use much care when handling the balance and observe the following when transporting the balance.

- Use the original packing material for transportation.
- Remove the weighing pan, pan support, breeze break ring and dust plate from the main unit.

24. Connection With Peripheral Device

Download "Communication manual" from our website (<https://www.aandd.jp>) and refer to it.

24-1. Command

Download "Communication manual" from our website (<https://www.aandd.jp>) and refer to it.

24-2. Key Lock Function

This function restricts the key operation of the balance by sending a specified command to the balance. Download "Communication manual" from our website (<https://www.aandd.jp>) and refer to it.

25. How To Check The Software Version Of The Balance

Specifications may vary depending on the balance software version.

Check the software version as follows.

1. Insert the AC adapter into the balance again.
2. `LEVEL` displays blinking.
3. `P-*.***` is displayed.
In place of " *.*** ", the software version is displayed.

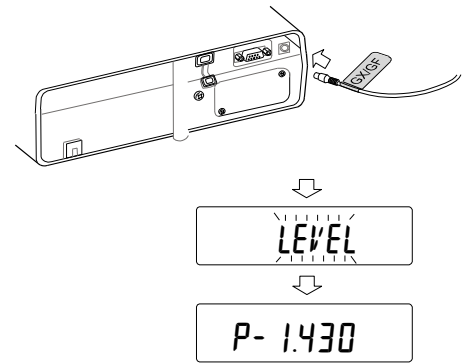

26. Specifications

26-1. Common Specifications

26-1-1 Function

Internal mass	Installed in GX-A/GX-AE/GX-AWP series models (Approximately 190g)		*1
Ionizer (static eliminator)	Installed in GX-AE series models		
Sensitivity drift (10 °C to 30 °C)	±2ppm / °C (When automatic sensitivity adjustment is OFF.)		
Operating environment	5 °C to 40 °C, 85%RH or less (no condensation)		
Display refresh rate	5 times/second, 10 times/second, or 20 times/second		
Display mode (unit)	g (gram), PCS (counting mode), % (percent mode), ct (Metric carat), mom (Momme) and density mode		*2
Counting mode	Number of samples	5, 10, 25, 50 or 100 pieces	
Percent mode	Readability	0.01%, 0.1%, 1% (Automatically changed by 100% mass)	
Interface	RS-232C, USB		
AC adapter	Confirm that the adapter type is correct for the local voltage and power receptacle type. Power consumption: Approx. 30 VA (supplied to the AC adapter)		
Current consumption	DC12V, approx. 0.3A (excluding the AC adapter and options)		

*1 The mass of the internal mass may change due to corrosion or other damage caused by the operating environment, or it may change due to aging.

*2 For 0.0001g models, "mg" is available.

26-1-2 Size/Weight

Model	0.0001g	0.001g	0.01g	0.1g
Weighing pan size	φ90 mm	128 x 128 mm	165 x 165 mm	
Net weight	Approx. 7 kg	Approx. 5 kg	Approx. 5 kg	
External dimensions	259 (W) x 358 (D) x 332 (H) mm (with glass breeze break)	212 (W) x 317 (D) x 171 (H) mm (with small breeze break) GX-AWP/GF-AWP series only, 212 (W) x 326 (D) x 171 (H) mm	212 (W) x 317 (D) x 93 (H) mm GX-AWP/GF-AWP series only, 212 (W) x 326 (D) x 171 (H) mm	

26-2. Individual Specifications

26-2-1 0.0001g Models

		GX-124AE GX-124A GF-124A	GX-224AE GX-224A GF-224A	GX-324AE GX-324A GF-324A
Weighing capacity		122g	220g	320g
Maximum display		122.0084g	220.0084g	320.0084g
Readability		0.0001g		
Repeatability (Standard deviation)		0.0001g		0.0002g (300g) 0.0001g (200g)
Linearity		± 0.0002g		± 0.0003g
Stabilization time (FAST setting, good environment)		Approx. 1.5 sec (100g)	Approx. 2 sec (200g) Approx. 1.5 sec (100g)	Approx. 2 sec (300g) Approx. 1.5 sec (100g)
Counting mode	Minimum unit mass	0.0001g		
Percent mode	Minimum 100% mass	0.0100g		
External sensitivity adjustment weight		100g (factory setting) 100g 50g	200g (factory setting) 200g 100g 50g	200g (factory setting) 300g 200g 100g 50g

26-2-2 0.001g Models

	GF-123A	GX-203A GF-203A GX-203AWP*2 GF-203AWP*2	GX-303A GF-303A	GX-403A GF-403A GX-403AWP*2 GF-403AWP*2	GX-603A GF-603A GX-603AWP*2 GF-603AWP*2	GX-1003A GF-1003A	GX-1603A GF-1603A	
Weighing capacity	122g	220g	320g	420g	620g	1100g	1620g	
Maximum display	122.084g	220.084g	320.084g	420.084g	620.084g	1100.084g	1620.084g	
Readability	0.001g							
Repeatability (Standard deviation)	0.001g						0.002g (1600g) 0.001g (1000g)	
Linearity	±0.002g					±0.003g		
Stabilization time (FAST setting, good environment)	Approx. 1 sec Approx. 0.8 sec (5g)						Approx. 1.5 sec Approx. 0.8 sec (5g)	
Accuracy after sensitivity adjustment with internal mass*1	±0.010g						±0.010g (1000g)	
Counting mode	Minimum unit mass	0.001g						
Percent mode	Minimum 100% mass	0.100g						
External sensitivity adjustment weight	100g 50g	200g (factory setting)	200g (factory setting)	400g (factory setting)	500g (factory setting)	1000g (factory setting)	1000g (factory setting)	
		200g 100g 50g	300g to 100g (100g interval) 50g	400g to 100g (100g interval) 50g	600g to 100g (100g interval) 50g	1000g to 100g (100g interval) 50g	1600g to 100g (100g interval) 50g	

*1 The operating environment is free from the effects of sudden changes in temperature and humidity, vibration, wind, magnetism, and static electricity.

*2 Compliant with IP65

26-2-3 0.01g Models

	GF-1202A	GX-2002A GF-2002A GX-2002AWP*2 GF-2002AWP*2	GX-3002A GF-3002A	GX-4002A GF-4002A GX-4002AWP*2 GF-4002AWP*2	GX-6002A GF-6002A GX-6002AWP*2 GF-6002AWP*2	GX-10002A GF-10002A
Weighing capacity	1220g	2200g	3200g	4200g	6200g	10200g
Maximum display	1220.84g	2200.84g	3200.84g	4200.84g	6200.84g	10200.84g
Readability	0.01g					
Repeatability (Standard deviation)	0.01g					0.02g (10000g) 0.01g (5000g)
Linearity	±0.02g			±0.03g		
Stabilization time (FAST setting, good environment)	Approx. 1 sec Approx. 0.8 sec (50g)					Approx. 1.5 sec (10g) Approx. 0.8 sec (50g)
Accuracy after sensitivity adjustment with internal mass*1	±0.10g		±0.15g		±0.15g (5000g)	
Counting mode	Minimum unit mass	0.01g				
Percent mode	Minimum 100% mass	1.00g				
External sensitivity adjustment weight	1000g 500g	2000g (factory setting)	2000g (factory setting)	4000g (factory setting)	5000g (factory setting)	10000g (factory setting)
		2000g 1000g 500g	3000g to 1000g (1000g interval) 500g	4000g to 1000g (1000g interval) 500g	6000g to 1000g (1000g interval) 500g	10000g to 1000g (1000g interval) 500g

*1 The operating environment is free from the effects of sudden changes in temperature and humidity, vibration, wind, magnetism, and static electricity.

*2 Compliant with IP65

26-2-4 0.1g Model

		GX-6001A GF-6001A GX-6001AWP*2 GF-6001AWP*2	GX-10001A GF-10001A
Weighing capacity		6200g	10200g
Maximum display		6208.4g	10208.4g
Readability		0.1g	
Repeatability (Standard deviation)		0.1g	
Linearity		±0.1g	
Stabilization time (FAST setting, good environment)		Approx. 1 sec Approx. 0.8 sec (500g)	
Accuracy after sensitivity adjustment with internal mass*1		±0.5g (5000g)	
Counting mode	Minimum unit mass	0.1g	
Percent mode	Minimum 100% mass	10.0g	
External sensitivity adjustment weight		5000g (factory setting) 6000g to 1000g (1000g interval) 500g	10000g (factory setting) 10000g to 1000g (1000g interval) 500g

*1 The operating environment is free from the effects of sudden changes in temperature and humidity, vibration, wind, magnetism, and static electricity.

*2 Compliant with IP65

27. External Dimensions

GX-124AE / GX-224AE / GX-324AE

GX-124A / GX-224A / GX-324A

GF-124A / GF-224A / GF-324A

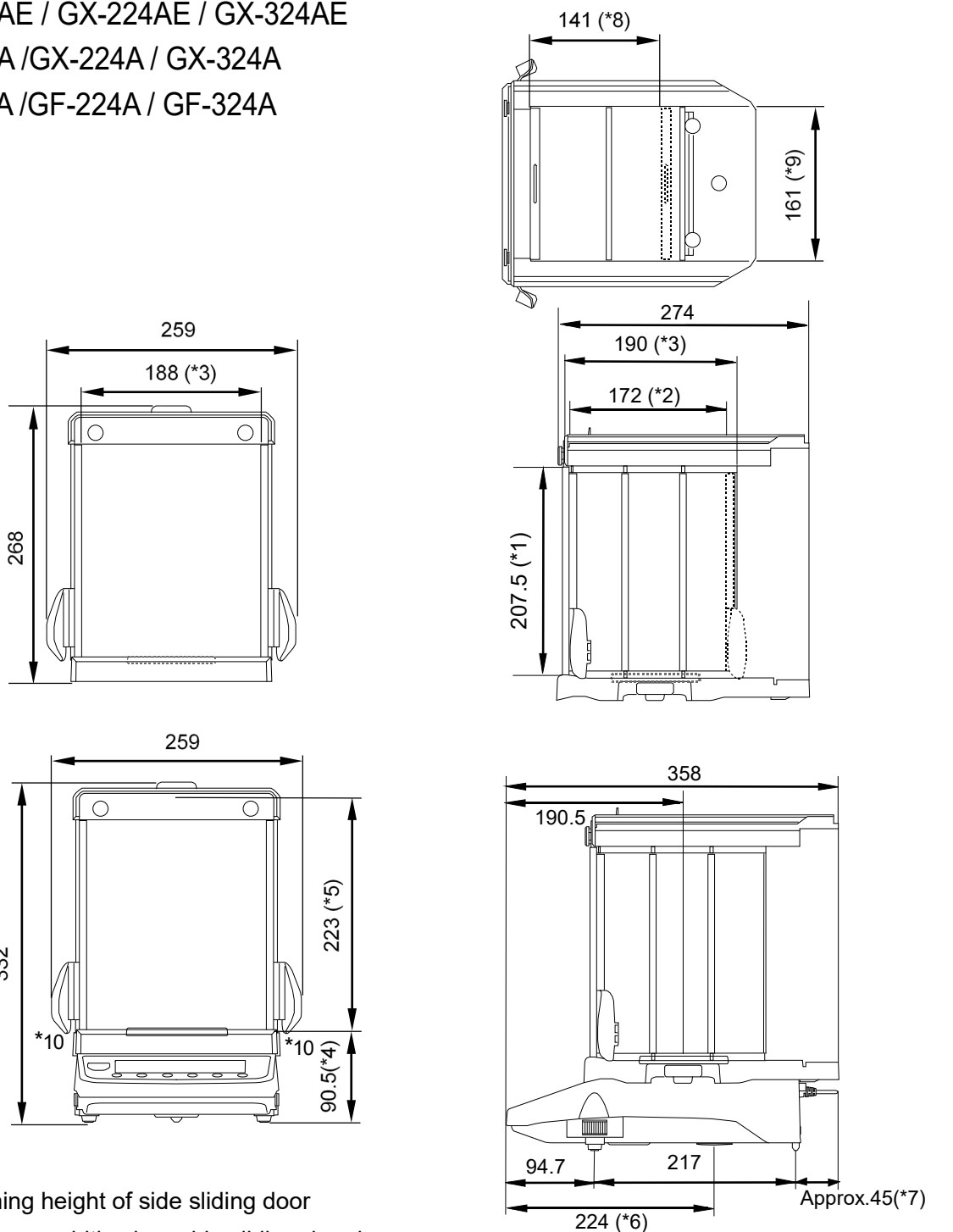

- *1 Opening height of side sliding door
- *2 Maximum width when side sliding door is open
- *3 Inside dimension
- *4 Height of weighing pan
- *5 Height from the weighing pan to the top of the sliding door of the glass breeze break
- *6 Area under the floor weighing platform
- *7 DC jack protruding dimension of AC adapter
- *8 Maximum height of the sliding door when open
- *9 Width of the top of the sliding door when open
- *10 Cannot open doors on both sides at the same time.

(Unit: mm)

GX-203A / GX-303A / GX-403A / GX-603A / GX-1003A / GX-1603A
 GF-123A / GF-203A / GF-303A / GF-403A / GF-603A / GF-1003A / GF-1603A
 GX-203AWP / GX-403AWP / GX-603AWP
 GF-203AWP / GF-403AWP / GF-603AWP

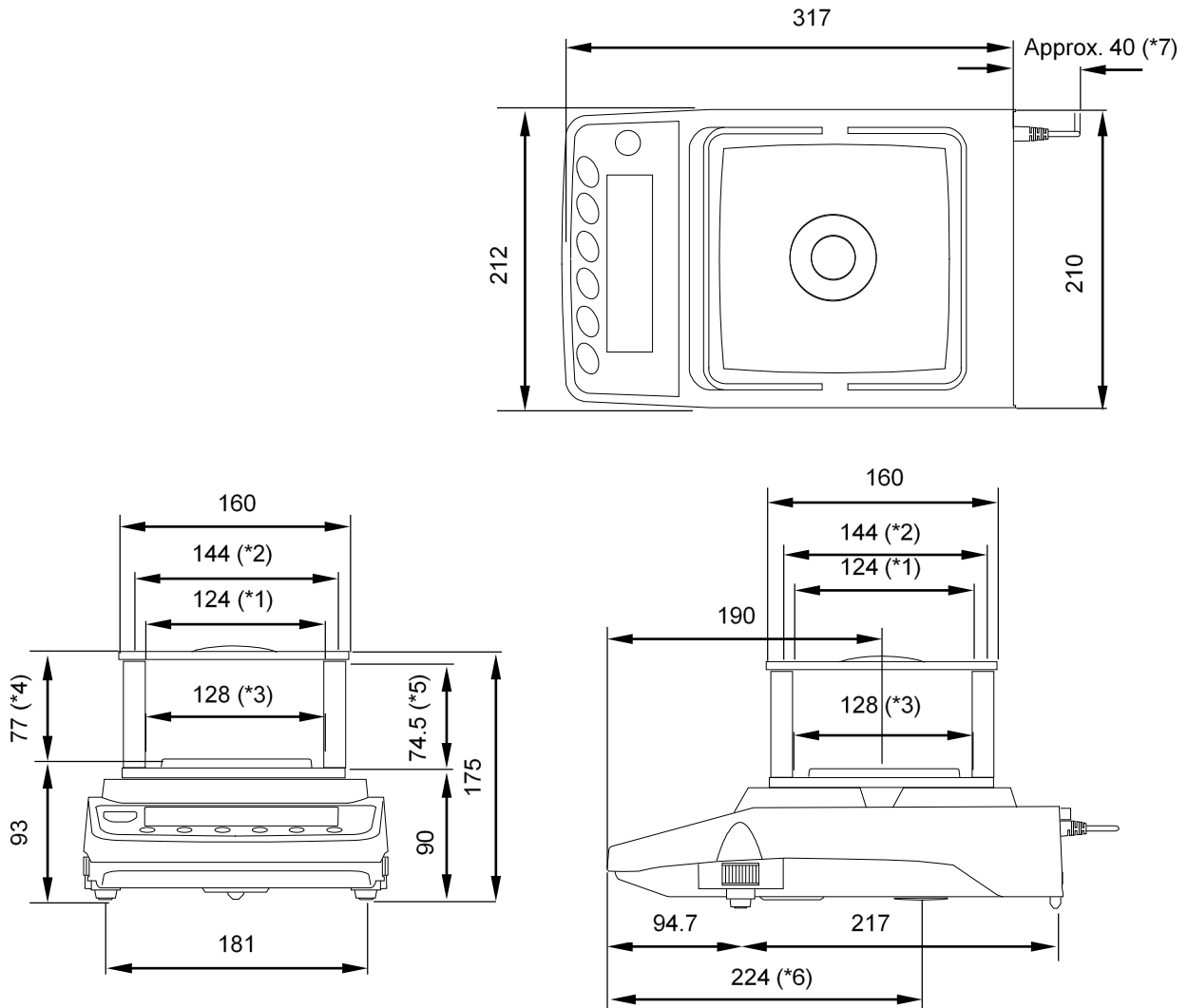

(Unit: mm)

- *1 Opening width when transparent plate is removed.
- *2 Inside dimension
- *3 Weighing pan size
- *4 Height from the weighing pan to the lid of the breeze break.
- *5 Opening height when transparent plate is removed.
- *6 Area under the floor weighing platform.
- *7 DC jack protruding dimension of AC adapter.

GX-2002A / GX-3002A / GX-4002A / GX-6002A / GX-10002A/ GX-6001A/ GX-10001A
 GF-1202A / GF-2002A / GF-3002A / GF-4002A / GF-6002A / GF-10002A/ GF-6001A /
 GF-10001A
 GX-2002AWP / GX-4002AWP / GX-6002AWP / GX-6001AWP
 GF-2002AWP / GF-4002AWP / GF-6002AWP / GF-6001AWP

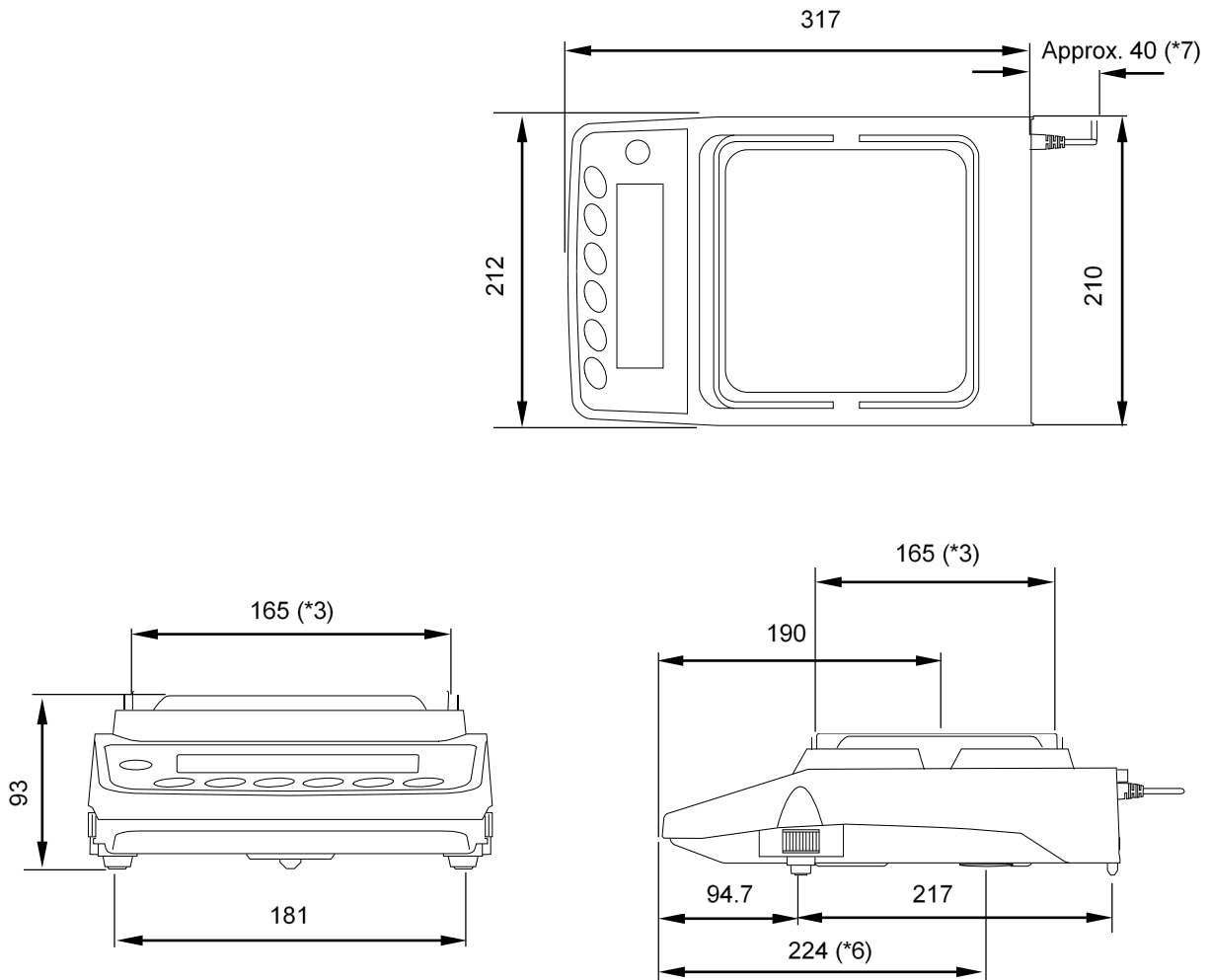

(Unit: mm)

- *3 Weighing pan size
- *6 Area under the floor weighing platform.
- *7 DC jack protruding dimension of AC adapter.

27-1. Options And Peripheral Instruments

Options

GXA-03: 2nd RS-232C interface

- RS-232C Interface insulation type for expansion

GXA-04: Comparator relay output / buzzer / external key input interface

- Outputs comparator results.

GXA-06: Analog output interface (factory-installed / dealer option)

- This option outputs a voltage of 0 to1V (or 0.2 to1V).

Fxi-08: Ethernet interface

- Enables the balance to communicate with computers on a network.
- Multiple balances on a network can be controlled by one computer.

GXA-09: Built-in rechargeable battery (factory-installed / dealer option)

- Enables the balance to be used in an environment where the AC adapter cannot be used.
- Charging time is approximately 10 hours, and continuous use time is approximately 14 hours.
- When installed in the GX-AWP/GF-AWP, the dustproof and waterproof structure is maintained.

GXA-10: Large glass breeze break

- Breeze break unit with a glass door

GXA-12: Animal weighing pan (for models of 320g capacity or higher)

- Container with depth to make it difficult for animals to escape

GXA-13: Density determination kit (for the 0.001g models only)

- Unit that enables easy weighing of the sample's weight in air and in water.

GXA-14: Density determination kit (for the 0.0001g models only)

- Unit that enables easy weighing of the sample's weight in air and in water.

GXA-17: Large glass breeze break with built-in fanless ionizer and external IR switch

- GX-10 breeze break unit with ionizer

GXA-23-PRINT: External key input interface + the AX-SW137-PRINT foot switch

- External contact input terminal that can operate PRINT and RE-ZERO key.

Foot switch of print function included. (AX-SW137-PRINT)

GXA-23-RE-ZERO: External key input interface + the AX-SW137-REZERO foot switch

- External contact input terminal that can operate PRINT and RE-ZERO key.

Foot switch of RE-ZERO function included. (AX-SW137-REZERO)

GXA-23-PLUG : External key input interface + the AX-T-314A-S plug

- External contact input terminal that can operate PRINT and RE-ZERO key.

Three assembled stereo plugs are included.

Note: In order to use, it is necessary to solder the attached plug and the switch prepared by the customer.

GXA-24: USB host interface (factory-installed / dealer option)

- Stores the weighing value in the USB memory.

GXA-25: Fanless ionizer of Quick Ion technology

- This ionizer (static eliminator) unit can be connected to and installed near the GX-AE/GX-A/GF-A series.

GXA-26: External IR switch

- External touchless switch that can operate PRINT and RE-ZERO key.

GXA-27: Output to Bluetooth®

- Weighing value can be entered into computers, tablets, and smartphones that have Bluetooth®, with an HID device being connected.
- AD8541-PC-JA, which is a dongle for connecting to computers, enables wireless communication with computers by commands.

*Please contact your local A&D representative to find out whether GXA-27 is certified for compliance with Bluetooth® communication laws in your country.

AX-GXA-31: Main unit cover (5 pieces)

- Protective cover for standard accessories

Peripheral devices

AD-8920A: Remote Display

- This option can be connected to the balance using the RS-232C interface or current loop and displays the weighing data transmitted by the balance.

AD-8922A: Remote Controller

- This option can be connected to the balance using the RS-232C interface and can control the balance remotely.

AD-8127: Compact printer

- Small dot impact printer that connects with the balance via the RS-232C interface.
- Statistical function, clock and calendar function, interval print function, graphic print function, dump print mode

AD-1683/AD-1683A: Ionizer

- Static eliminator that prevents error which can be caused when weighing samples are electrically charged.
- Its direct-current system and plentiful ion content enable weighing without breeze, which is ideally suited for precisely measuring powder and such.
- The built-in IR Sensor enables removal of static electricity in a touchless way. (AD-1683A only)

AD-1684A: Static electricity indicator

- An indicator that measures how much the balance's peripheral devices (e.g. automatic weighing line) such as weighing samples, tare, and breeze break are electrically charged and shows the result. When electric charge is observed, it can be eliminated with AD-1683 (Ionizer).

AD-1687: Weighing Environment logger

- A data logger equipped with 4 sensors for temperature, humidity, barometric pressure and vibration that can measure and store environmental data. When connected to the RS-232C interface of the balance, the AD-1687 can store environmental data along with weighing data. Therefore, it is possible to store data in an environment where a computer cannot be used.

AD-1688: Weighing data logger

- When connected to the RS-232C interface of the balance, the AD-1688 can store the data in an environment where a personal computer can not be used.

AD-1689: Tweezers for sensitivity adjustment weight

- A pair of tweezers ideally suited for holding sensitivity adjustment weights of 1g to 500g.

AX-USB-9P: Serial / USB Converter

- An RS-232C cable is provided to connect the USB converter to the balance.
- Enables bi-directional communication between the PC and the balance when a USB driver is installed.

AX-SW137-PRINT: Foot switch for print (with connector)

- Foot switch that functions in the same way as the PRINT key when combined with GXA-23 external connector

AX-SW137-REZERO: Foot switch for re-zero (with connector)

- Foot switch that functions in the same way as the RE-ZERO key when combined with GXA-23 external connector

AX-BM-NEEDLESET: Electrode units for the ionizer (4 pieces)

- Electrode unit replacement for ionizer. When replacing, please replace two at the same time. For how to replace, refer to "Maintenance of the electrode unit" in the manual of "GXA-17 Large Glass Breeze Break with Ionizer" which can be downloaded from our website (<https://www.aandd.jp>).



A&D Company, Limited

3-23-14 Higashi-Ikebukuro, Toshima-ku, Tokyo 170-0013, JAPAN

Telephone: [81] (3) 5391-6132

Fax: [81] (3) 5391-1566

A&D ENGINEERING, INC.

1756 Automation Parkway, San Jose, California 95131, U.S.A.

Telephone: [1] (408) 263-5333

Fax: [1] (408) 263-0119

A&D INSTRUMENTS LIMITED

Unit 24/26 Blacklands Way, Abingdon Business Park, Abingdon, Oxfordshire OX14 1DY United Kingdom

Telephone: [44] (1235) 550420

Fax: [44] (1235) 550485

A&D AUSTRALASIA PTY LTD

32 Dew Street, Thebarton, South Australia 5031, AUSTRALIA

Telephone: [61] (8) 8301-8100

Fax: [61] (8) 8352-7409

A&D KOREA Limited

한국에이.엔.디(주)

서울특별시 영등포구 국제금융로6길33 (여의도동) 맨하탄빌딩 817 우편 번호 07331

(817, Manhattan Bldg., 33. Gukjegeumyung-ro 6-gil, Yeongdeungpo-gu, Seoul, 07331 Korea)

전화: [82] (2) 780-4101

팩스: [82] (2) 782-4264

OOO A&D RUS

ООО "ЭЙ энд ДИ РУС"

Почтовый адрес: 121357, Российская Федерация, г.Москва, ул. Верейская, дом 17

Юридический адрес: 117545, Российская Федерация, г. Москва, ул. Дорожная, д.3, корп.6, комн. 86

(121357, Russian Federation, Moscow, Vereyskaya Street 17)

тел.: [7] (495) 937-33-44

факс: [7] (495) 937-55-66

A&D Instruments India Private Limited

ऐ&डी इन्स्ट्र्यूमेन्ट्स इण्डिया प्रा० लिमिटेड

509, उद्योग विहार , फेस -5, गुडगांव - 122016, हरियाणा , भारत

(509, Udyog Vihar, Phase-V, Gurgaon - 122016, Haryana, India)

फोन : [91] (124) 4715555

फैक्स : [91] (124) 4715599

A&D SCIENTECH TAIWAN LIMITED. A&D台灣分公司 艾安得股份有限公司

台灣台北市中正區青島東路5號4樓

(4F No.5 Ching Tao East Road, Taipei Taiwan R.O.C.)

Tel : [886](02) 2322-4722

Fax : [886](02) 2392-1794

A&D INSTRUMENTS (THAILAND) LIMITED

บริษัท เอ แอนด์ ดี อินสตรูमेंท์ (ไทยแลนด์) จำกัด

168/16 หมู่ที่ 1 ตำบลรังสิต อำเภอธัญบุรี จังหวัดปทุมธานี 12110 ประเทศไทย

(168/16 Moo 1, Rangsit, Thanyaburi, Pathumthani 12110 Thailand)

Tel : [66] 20038911